

Teste portacoltelli sagomati

Sonder
-Profil-Messerköpfe

Porte-outils profilé
à plaquettes interchangeable

Профильные головки
со сменными ножами

TS02

HW Profiled cutterheads



Teste sagomate costruite con corpo in acciaio bonificato • 2 coltellini in HW a fissaggio meccanico • Indicate per lavorazioni su toupie, scorniciatrici etc.

Profiled cutter heads with steel hardened and tempered body • 2 turnover knives in HW fixed with the clamping device by means of Clamping wedges • To use on toupie, double end tenoners, moulding machine, etc.

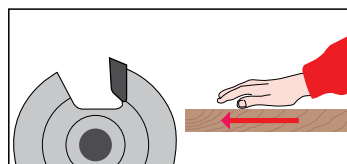
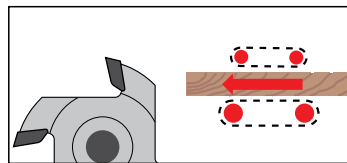
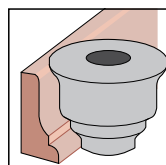
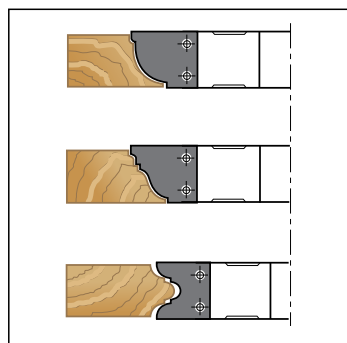
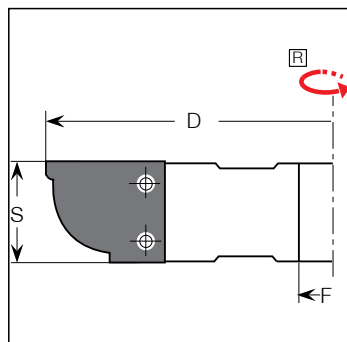

Z=2

● = Ready in stock ■ = Delivery time 20 working days ▲ = On request

D	S	F	Code	€
120	20	30	▲ TS02M12020AA	258,60
120	25	30	▲ TS02M12025AA	270,00
120	30	30	▲ TS02M12030AA	284,80
120	35	30	▲ TS02M12035AA	297,00
120	40	30	▲ TS02M12040AA	308,40
120	50	30	▲ TS02M12050AA	335,60
120	60	30	▲ TS02M12060AA	361,80
120	80	30	▲ TS02M12080AA	412,80
160	20	30	▲ TS02M16020AA	274,20
160	25	30	▲ TS02M16025AA	287,40
160	30	30	▲ TS02M16030AA	301,40
160	35	30	▲ TS02M16035AA	314,60
160	40	30	▲ TS02M16040AA	327,80
160	50	30	▲ TS02M16050AA	356,60
160	60	30	▲ TS02M16060AA	383,80
160	80	30	▲ TS02M16080AA	439,00
200	20	40	▲ TS02M20020AA	289,20
200	25	40	▲ TS02M20025AA	303,20
200	30	40	▲ TS02M20030AA	318,00
200	35	40	▲ TS02M20035AA	330,40
200	40	40	▲ TS02M20040AA	343,40
200	50	40	▲ TS02M20050AA	372,40
200	60	40	▲ TS02M20060AA	400,40
200	80	40	▲ TS02M20080AA	455,60
Spec.			TS2M99	

NOTE

Il prezzo include coltelli profilati e una chiave di regolazione.
The price included profiled knives and one screwdriver.

TAGLIO / SEZIONATURA
SAWING

DIAMANTE
DIAMOND

FRESATURA
CUTTING

PANTOGRAFATURA
ROUTING

FORATURA
BORING

MANDRINI / ATTACCHI
CHUCKS & CLAMPING SYSTEM

RICAMBI E LAVORAZIONI SUPP.
SPARE PARTS & ADD. WORKING

Teste portacoltelli sagomati

Sonder
-Profil-Messerköpfe

Porte-outils profilé
à plaquettes interchangeable

Профильные головки
со сменными ножами

TS03

HW Profile cutterheads



Teste sagomate costruite con corpo in acciaio bonificato • 3 coltelli in HW a fissaggio meccanico • Indicate per lavorazioni su toupie, sorniciatrici etc.

Profiled cutter heads with steel hardened and tempered body • 3 HW turnover knives • To use on toupie and moulding machine

TAGLIO / SEZIONATURA
SAWING

DIAMANTE
DIAMOND

FRESATURA
CUTTING

PANTOGRAFATURA
ROUTING

FORATURA
BORING

MANDRINI / ATTACCHI
CHUCKS & CLAMPING SYSTEM

RICAMBI E LAVORAZIONI SUPP.
SPARE PARTS & ADD. WORKING

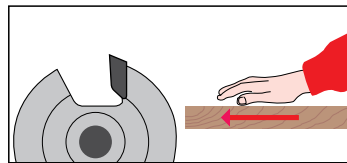
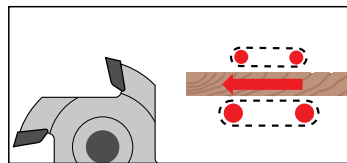
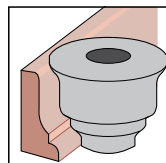
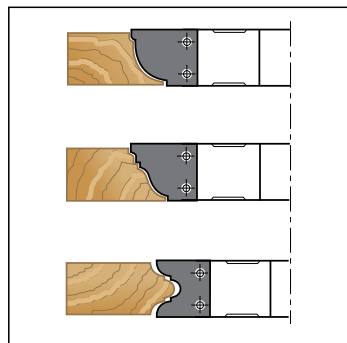
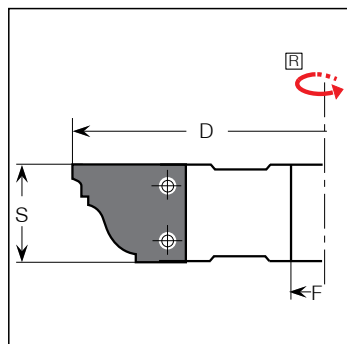

Z=3

● = Ready in stock ■ = Delivery time 20 working days △ = On request

D	S	F	Code	€
120	20	30	△ TS03M12020AA	293,80
120	25	30	△ TS03M12025AA	306,20
120	30	30	△ TS03M12030AA	322,80
120	35	30	△ TS03M12035AA	336,80
120	40	30	△ TS03M12040AA	350,00
120	50	30	△ TS03M12050AA	380,60
120	60	30	△ TS03M12060AA	409,60
120	80	30	△ TS03M12080AA	468,40
160	20	30	△ TS03M16020AA	309,60
160	25	30	△ TS03M16025AA	326,00
160	30	30	△ TS03M16030AA	341,00
160	35	30	△ TS03M16035AA	355,00
160	40	30	△ TS03M16040AA	371,60
160	50	30	△ TS03M16050AA	404,60
160	60	30	△ TS03M16060AA	435,20
160	80	30	△ TS03M16080AA	497,40
200	20	40	△ TS03M20020AA	327,80
200	25	40	△ TS03M20025AA	342,60
200	30	40	△ TS03M20030AA	360,80
200	35	40	△ TS03M20035AA	373,20
200	40	40	△ TS03M20040AA	388,20
200	50	40	△ TS03M20050AA	421,20
200	60	40	△ TS03M20060AA	453,40
200	80	40	△ TS03M20080AA	515,60
Spec.			TS3M99	

NOTE

Il prezzo include coltelli profilati e una chiave di regolazione.
The price included profiled knives and one screwdriver.

TS04

HW Profile cutterheads



Teste sagomate costruite con corpo in acciaio bonificato • 4 coltelli in HW a fissaggio meccanico • Indicate per lavorazioni su toupie, sorniciatrici etc.

Profiled cutter heads with steel hardened and tempered body • 4 HW turnover knives • To use on toupie and moulding machine

Z=4

● = Ready in stock ■ = Delivery time 20 working days △ = On request

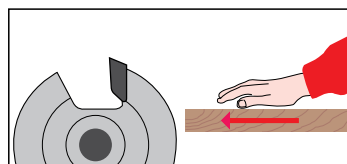
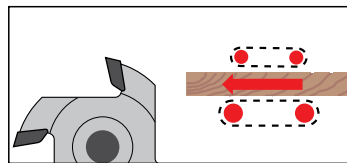
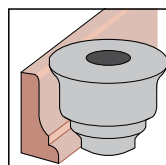
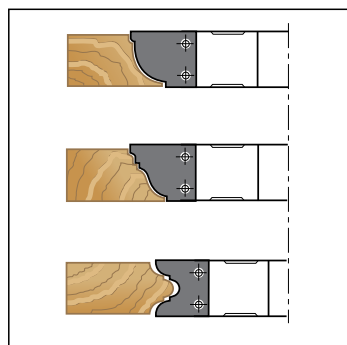
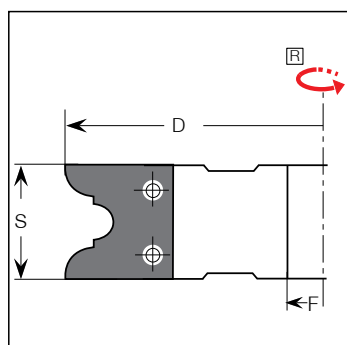

D	S	F	Code	€
120	20	30	△ TS04M12020AA	308,40
120	25	30	△ TS04M12025AA	322,40
120	30	30	△ TS04M12030AA	339,60
120	35	30	△ TS04M12035AA	355,20
120	40	30	△ TS04M12040AA	368,40
120	50	30	△ TS04M12050AA	401,20
120	60	30	△ TS04M12060AA	432,20
120	80	30	△ TS04M12080AA	493,80
160	20	30	△ TS04M16020AA	325,60
160	25	30	△ TS04M16025AA	342,80
160	30	30	△ TS04M16030AA	359,80
160	35	30	△ TS04M16035AA	375,40
160	40	30	△ TS04M16040AA	392,60
160	50	30	△ TS04M16050AA	426,80
160	60	30	△ TS04M16060AA	458,80
160	80	30	△ TS04M16080AA	525,00
200	20	40	△ TS04M20020AA	345,00
200	25	40	△ TS04M20025AA	359,80
200	30	40	△ TS04M20030AA	380,80
200	35	40	△ TS04M20035AA	394,20
200	40	40	△ TS04M20040AA	409,60
200	50	40	△ TS04M20050AA	444,00
200	60	40	△ TS04M20060AA	478,20
200	80	40	△ TS04M20080AA	543,60
Spec.			TS04M99	

NOTE

Il prezzo include coltelli profilati e una chiave di regolazione.
The price included profiled knives and one screwdriver.

TAGLIO / SEZIONATURA
SAWING

DIAMANTE
DIAMOND

FRESATURA
CUTTING

PANTOGRAFATURA
ROUTING

FORATURA
BORING

MANDRINI / ATTACCHI
CHUCKS & CLAMPING SYSTEM

RICAMBI E LAVORAZIONI SUPP.
SPARE PARTS & ADD. WORKING

Teste portacoltelli sagomati

Sonder
-Profil-Messerköpfe

Porte-outils profilé
à plaquettes interchangeable

Профильные головки
со сменными ножами

TS06

HW Profile cutterheads

TAGLIO / SEZIONATURA
SAWING



Teste sagomate costruite con corpo in acciaio bonificato • 6 coltelli in HW a fissaggio meccanico • Indicate per lavorazioni su tosupie, sorniciatrici etc.

Profiled cutter heads with steel hardened and tempered body • 6 HW turnover knives • To use on toupie and moulding machine

DIAMANTE
DIAMOND

FRESATURA
CUTTING

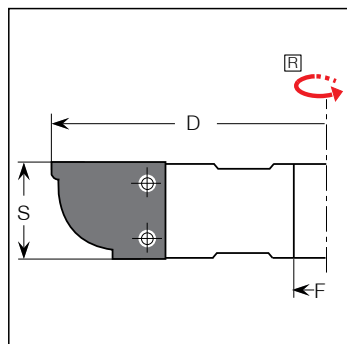

PANTOGRAFATURA
ROUTING

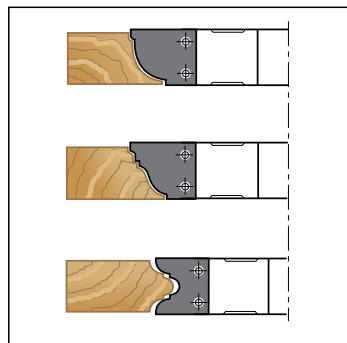

FORATURA
BORING

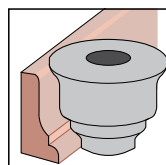

MANDRINI / ATTACCHI
CHUCKS & CLAMPING SYSTEM

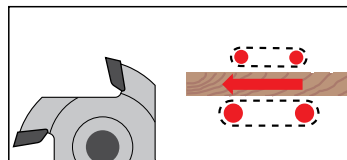

RICAMBI E LAVORAZIONI SUPP.
SPARE PARTS & ADD. WORKING

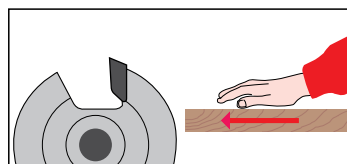

Z=6

● = Ready in stock ■ = Delivery time 20 working days △ = On request

D	S	F	Code	€
120	20	30	△ TS06M12020AA	426,20
120	25	30	△ TS06M12025AA	446,00
120	30	30	△ TS06M12030AA	469,20
120	35	30	△ TS06M12035AA	490,80
120	40	30	△ TS06M12040AA	509,00
120	50	30	△ TS06M12050AA	554,40
120	60	30	△ TS06M12060AA	597,40
120	80	30	△ TS06M12080AA	682,60
160	20	30	△ TS06M16020AA	450,20
160	25	30	△ TS06M16025AA	473,40
160	30	30	△ TS06M16030AA	497,40
160	35	30	△ TS06M16035AA	518,80
160	40	30	△ TS06M16040AA	542,80
160	50	30	△ TS06M16050AA	590,00
160	60	30	△ TS06M16060AA	633,80
160	80	30	△ TS06M16080AA	725,60
200	20	40	△ TS06M20020AA	477,40
200	25	40	△ TS06M20025AA	497,40
200	30	40	△ TS06M20030AA	523,80
200	35	40	△ TS06M20035AA	544,40
200	40	40	△ TS06M20040AA	566,00
200	50	40	△ TS06M20050AA	613,20
200	60	40	△ TS06M20060AA	661,20
200	80	40	△ TS06M20080AA	751,40
Spec.			TS06M99	

NOTE

Il prezzo include coltelli profilati e una chiave di regolazione.
The price included profiled knives and one screwdriver.

T108

HW Multi profile cutter head

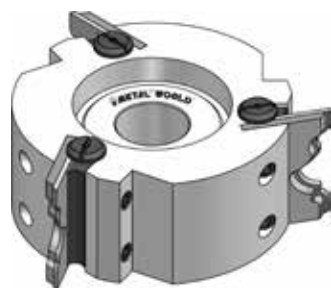

Costruite con corpo in acciaio bonificato • 3 coltelli in HW e coltello di supporto in acciaio (spessore 5 mm) fornibili a parte profilati o grezzi* • Adatte per la lavorazione di legni massicci • Da montare su macchine scorniciatrici in generale

Body in hardened and tempered steel • 3 HW profiled knives and steel support plates (thickness 5 mm) supplied separately profiled or not profiled* • Suitable for working solid wood • Can be used on moulding machines

Z=3

● = Ready in stock ■ = Delivery time 20 working days △ = On request

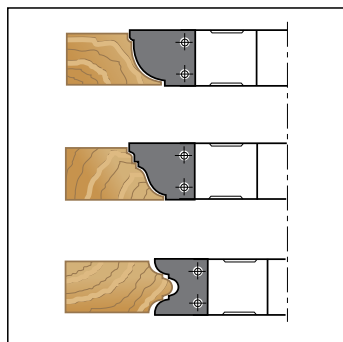
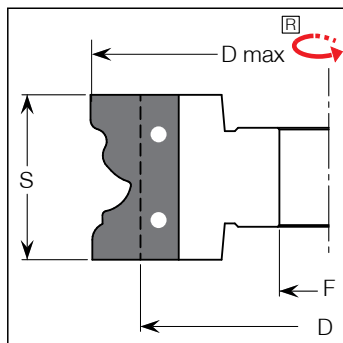

Coltello / Knife

H (mm)	P (mm)
30	10
35	16

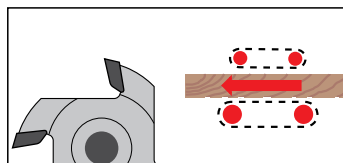
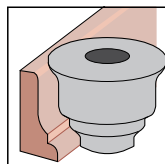

D	Dmax	S	F	Code	€
120	140	40	30	△ T108M12040AA	343,60
120	140	60	30	△ T108M12060AA	380,60
120	140	80	30	△ T108M12080AA	438,20
140	156	40	30	△ T108M14040AA	371,00
140	156	60	30	△ T108M14060AA	407,00
140	156	80	30	△ T108M14080AA	467,40
Spec.				T108M99	

SPARE PARTS

Type	Dimensions	Code	€
Knife	40X30X2	△ SSCT10840302	22,50
Knife	60X30X2	△ SSCT10860302	25,80
Knife	80X30X2	△ SSCT10880302	42,00
Knife	40X35X2	△ SSCT10840352	25,80
Knife	60X35X2	△ SSCT10860352	37,80
Knife	80X35X2	△ SSCT10880352	48,30
Support plate	40X33X5	△ SCCT10840335	18,00
Support plate	60X33X5	△ SCCT10860335	20,60
Support plate	80X33X5	△ SCCT10880335	33,60
Support plate	40X40X5	△ SCCT10840405	20,60
Support plate	60X40X5	△ SCCT10860405	30,20
Support plate	80X40X5	△ SCCT10880405	38,60
Clamping wedge	36X10X10	● ETASS36	12,60
Clamping wedge	56X10X10	● ETASS56	15,00
Clamping wedge	76X10X10	● ETASS76	16,00
Wedge screw	M8X16	● WV085	1,00
"T" allen key	Esag. 4	● ACHET04AAAAA	8,20

* Coltelli e controcoltelli PROFILATI fornibili a parte.

* PROFILED Knives and supports are not included, on request they are supplied according your needs.

NOTE

Il prezzo include coltelli e controcoltelli NON profilati e una chiave di regolazione.
Unprofiled knives and supports are included in the price as well as allen key.

Teste portacoltelli per Lamello®

Lamello®
Nut-Messerköpfe

Porte-outils à rainer pour Lamello®

Фрезы радиусные для кромочных станков

T109

HW Grooving cutterheads

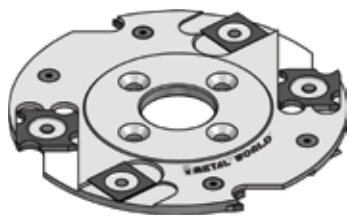

Costruite con corpo in acciaio bonificato • 4 coltelli e 4 rasanti in HW a fissaggio meccanico • Ottima finitura • Indicate per l'esecuzione di incastri per lamello® • Da montare su macchine utensili lamello e macchine CNC

Body in hardened and tempered steel • 4 turnover knives and 4 spurs in HW • Excellent finish • Suitable for lamello® grooving executions • Can be used on power tools Lamello and CNC machines

Z=4 V=4

● = Ready in stock ■ = Delivery time 20 working days △ = On request

D	S	F	PH	Code	€
100	4	22	4/M4/36	● T109M10004AA	131,80
Spec.				T109M99	

SPARE PARTS

Type	Dimensions	Per S	Code	€
Reversible knife	18X18X1,9	4	● C100M181819	7,10
Spur	14X14X1,2	4	● C040M14012AA	2,40
Screw c.e.r.	M4X3,2X6	4	● WV010	3,00
Screw c.e.r.	M4X4X6	5-6	● WV011	3,00
Screwdriver	Torx9	4-5-6	● ACHTC09AAAAA	9,40

NOTE

■ Utensili non a magazzino, quantità minima d'ordine: **2 pezzi**.
Tools not ready in stock minimum order quantity: **2 pieces**.

Il prezzo include coltelli e una chiave di regolazione.
The price included knives and a screwdriver.

Mandrini per Lamello®

Nutrfräsaufnahme

Arbre pour scie Lamello®

Хвостовик для Lamello®

M788

Shank for Lamello®



Costruite con corpo in acciaio bonificato • Taglienti in HW • Affilatura piana • Adatte, in base alla dentatura • Indicate per la realizzazione di incastri per Lamello • Adatte alla lavorazione di legni naturali, pannelli truciolari o MDF grezzi e/o rivestiti • Utilizzabili su macchine manuali e CNC

Obtained from hardened and tempered steel • Carbide tip • Flat geometry • Indicated for grooving cuts for Lamello • Suitable to cut chipboard or MDF panels lined on both sides • Used on manuals machine and CNC

SPARE PARTS

● = Ready in stock ■ = Delivery time 20 working days △ = On request

D	F	d	PH	Code	€
53	22	16	4/M4/36	● M78800532216	113,40
53	22	20	4/M4/36	● M78800532220	113,40

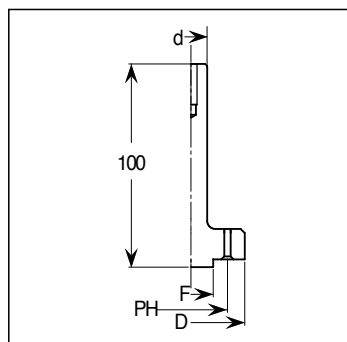

TAGLIO / SEZIONATURA
SAWING

DIAMANTE
DIAMOND

FRESATURA
CUTTING

PANTOGRAFATURA
ROUTING

FORATURA
BORING

MANDRINI / ATTACCHI
CHUCKS & CLAMPING SYSTEM

RICAMBI E LAVORAZIONI SUPP.
SPARE PARTS & ADD. WORKING

T110

HW Grooving cutterheads



Costruite con corpo in acciaio bonificato • 4 coltelli e 4 rasanti in HW a fissaggio meccanico • Ottima finitura • Indicate per l'esecuzione di scanalature di piccoli spessori • Da montare su macchine toupie, scorniciatrici, etc.

Body in hardened and tempered steel • 4 turnover knives and 4 spurs in HW • Excellent finish • Suitable for the execution of joints of small thickness • Can be used on toupie, moulding machines, etc.

Z=4 V=4

● = Ready in stock ■ = Delivery time 20 working days △ = On request

D	S	F	Code	€
120	4	30	■ T110M12004AA	206,40
120	5	30	■ T110M12005AA	212,20
120	6	30	■ T110M12006AA	214,20
140	4	30	● T110M14004AA	213,20
140	5	30	● T110M14005AA	219,20
140	6	30	● T110M14006AA	222,00
160	4	30	■ T110M16004AA	220,00
160	5	30	■ T110M16005AA	226,00
160	6	30	■ T110M16006AA	229,80

Spec.

T110M99

SPARE PARTS

Type	Dimensions	Per S	Code	€
Reversible knife	18X18X1,9	4	● C100M181819	7,10
Reversible knife	18X18X2,9	5-6	● C100M181829	10,60
Spur	14X14X1,2	4	● C040M14012AA	2,40
Spur	14X14X2	5-6	● C040M14020AA	2,40
Screw c.e.r.	M4X3,2X6	4	● WV010	3,00
Screw c.e.r.	M4X4X6	5-6	● WV011	3,00
Spur ring nut	9,9X1,6XM4	4	● WG001	1,40
Spur ring nut	9,35X1,7XM4	5-6	● WG002	1,40
Knife ring nut	11,8X1,6XM4	4	● WG003	1,40
Knife ring nut	11,8X1,7XM4	5-6	● WG004	1,40
Screwdriver	Torx9	4-5-6	● ACHTC09AAAAA	9,40

NOTE

■ Utensili non a magazzino, quantità minima d'ordine: **2 pezzi**.
Tools not ready in stock minimum order quantity: **2 pieces**.

Il prezzo include coltelli, rasanti e una chiave di regolazione.
The price included knives, spurs and a screwdriver.

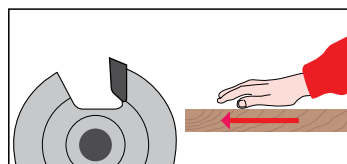
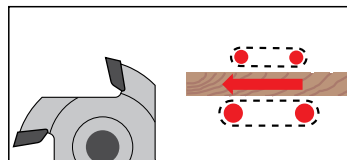
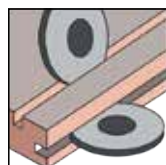
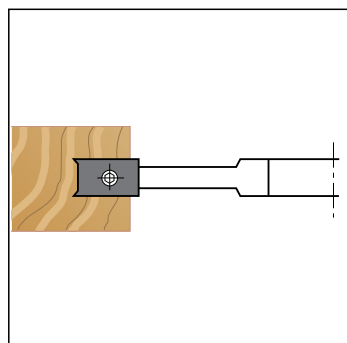
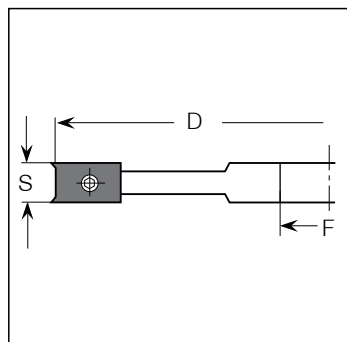

T112

HW Cutterheads for groove bed guide



Costruite con corpo in acciaio bonificato • 2 coltelli e 2 rasanti in HW a fissaggio meccanico • Indicate per lavorazioni su macchine Weing con banco rigato

Body in hardened and tempered steel • 2 turnover knives and 2 spurs in HW • Can be used on Weing machines

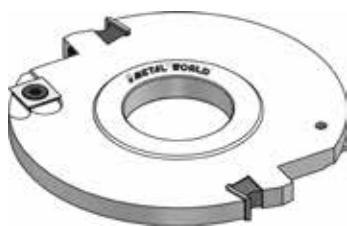

Z=2 V=2

● = Ready in stock ■ = Delivery time 20 working days △ = On request

D	S	F	Code	€
125	9	40	■ T112M12509AA	142,80
125	10	40	■ T112M12510AA	138,60
125	17	40	■ T112M12517AA	142,80
125	20	40	■ T112M12520AA	145,60
125	40	40	■ T112M12540AA	152,60
Spec.			T112M99	

SPARE PARTS

Type	Dimensions	Per S	Code	€
Reversible knife	8,6X12X1,5	9	● C020M08612AA	4,80
Reversible knife	9,6X12X1,5	10	● C020M09612AA	2,40
Reversible knife	16,6X12X1,5	17	● C020M16612AA	4,80
Spur	14X14X2	9-10-17	● C040M14020AA	2,40
Clamping wedge	7X10X10	9	● ETASS07	7,20
Clamping wedge	8X10X10	10	● ETASS08	8,10
Clamping wedge	15X10X10	17	● ETASS15	10,80
Spur screw	M5X8	9-10-17	● WV013	3,00
Knife screw	M6X12	9-10-17	● WV029	1,00
"T" allen key	Esag.3	9-10-17	● ACHET03AAAAA	7,40
"T" Torx key	Torx20	9-10-17	● ACHTT20AAAAA	14,60

NOTE

■ Utensili non a magazzino, quantità minima d'ordine: **2 pezzi**.
Tools not ready in stock minimum order quantity: **2 pieces**.

Il prezzo include coltelli, rasanti e 2 chiavi di regolazione.
The price included knives, spurs and 2 screwdrivers.

TAGLIO / SEZIONATURA
SAWING

DIAMANTE
DIAMOND

FRESATURA
CUTTING

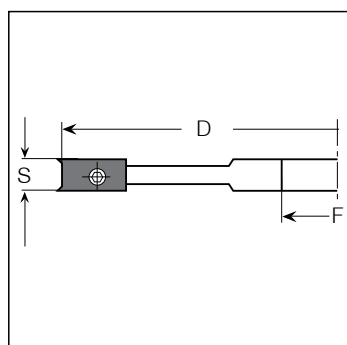

PANTOGRAFATURA
ROUTING

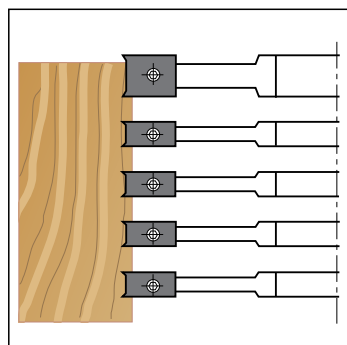

FORATURA
BORING

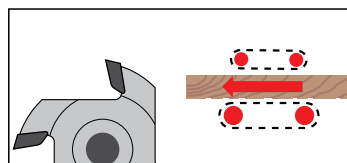

MANDRINI / ATTACCHI
CHUCKS & CLAMPING SYSTEM

RICAMBI E LAVORAZIONI SUPP.
SPARE PARTS & ADD. WORKING

T114

HW Grooving cutterheads



Costruite con corpo in acciaio bonificato • 4 coltelli e 4 rasanti in HW a fissaggio meccanico • Ottima finitura • Indicate per l'esecuzione di scanalature di spessori più grandi rispetto all'art.T110 • Da montare su macchine toupie, scorniciatrici, squadratrici etc.

Body in hardened and tempered steel • 4 turnover knives and 4 spurs in HW • Excellent finish • Suitable for the execution of joints larger than T110 • Can be used on toupie, moulding machines, etc.

Z=4 V=4

● = Ready in stock ■ = Delivery time 20 working days △ = On request

D	S	F	Code	€
120	8	30	■ T114M12008AA	192,80
120	10	30	■ T114M12010AA	210,40
120	12	30	■ T114M12012AA	217,20
140	8	30	■ T114M14008AA	206,40
140	10	30	■ T114M14010AA	214,20
140	12	30	■ T114M14012AA	223,00
160	8	30	■ T114M16008AA	212,20
160	10	30	■ T114M16010AA	221,00
160	12	30	■ T114M16012AA	229,80

Spec.

T114M99

SPARE PARTS

Type	Dimensions	Per S	Code	€
Reversible knife	7,5X12X1,5	8	● C020M07512AA	2,00
Reversible knife	9,6X12X1,5	10	● C020M09612AA	2,40
Reversible knife	11,6X12X1,5	12	● C020M11612AA	4,70
Spur	14X14X2	8-10-12	● C040M14020AA	2,40
Clamping wedge	6X10X10	8	● ETASS06	7,20
Clamping wedge	8X10X10	10	● ETASS08	8,10
Clamping wedge	9X10X10	12	● ETASS09	8,10
Knife screw	M5X12	8	● WV030	1,00
Knife screw	M6X12	10-12	● WV029	1,00
Spur screw	M5X6	8-10-12	● WV028	3,00
"T" allen key	Esag. 2,5	8	● ACHET25AAAAA	7,20
"T" allen key	Esag. 3	10-12	● ACHET03AAAAA	7,40
"T" Torx key	Torx20	8-10-12	● ACHTT20AAAAA	14,60

NOTE

■ Utensili non a magazzino, quantità minima d'ordine: **2 pezzi**.
Tools not ready in stock minimum order quantity: **2 pieces**.

Il prezzo include coltelli, rasanti e 2 chiavi di regolazione.
The price included knives, spurs and 2 screwdrivers.

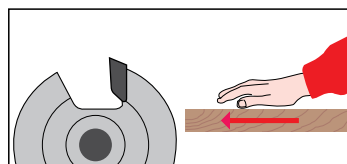
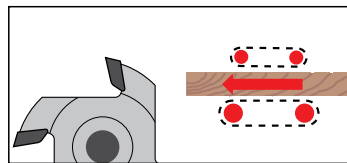
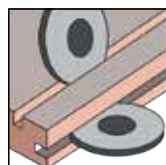
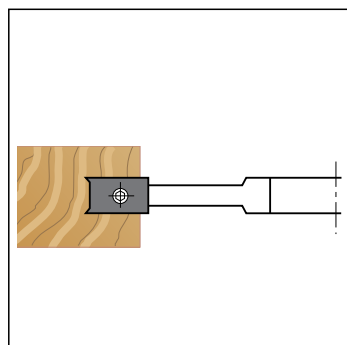
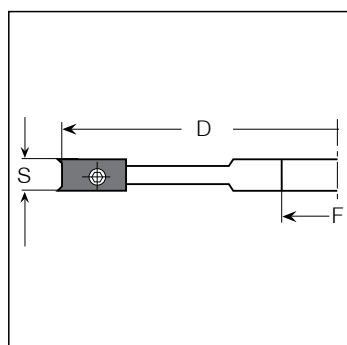

Teste portacoltelli per incastri sottili regolabili con anelli

Verstellbare Nut-Messerköpfe mit Distanzringe

Porte-outils à rainer extensible avec bagues de réglage

Регулируемые головки со сменными ножами для пазования

T120

HW Adjustable grooving cutterheads

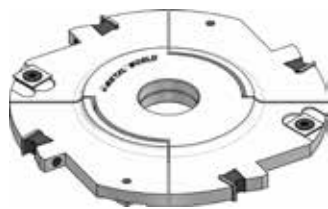

Costruite con corpo in acciaio bonificato • Coltelli e rasanti in HW a fissaggio meccanico • Ottima finitura • Indicate per l'esecuzione di scanalature di varie misure grazie alla regolazione mediante anelli distanziali • Da montare su macchine toupie, scorniciatrici, squadratrici etc.

Body in hardened and tempered steel • HW turnover knives and spurs • Excellent finish • Indicated for the execution of grooves of different thickness, regulation by means of spacer rings • Can be used on toupie, moulding machines, double end tenoner machines

● = Ready in stock ■ = Delivery time 20 working days △ = On request

D	S	Z	V	F	Code	€
160	4÷7,5	8	4	30	● T120M16004AA	273,80
160	6÷11	8	4	30	● T120M16006AA	285,60
160	8÷15	4	4	30	● T120M16008AA	257,00
160	10÷19,5	4	4	30	● T120M16010AA	270,40
160	12÷23,5	4	4	30	● T120M16012AA	261,80
200	4÷7,5	8	4	40	■ T120M20004AA	283,20
200	6÷11	8	4	40	■ T120M20006AA	295,20
200	8÷15	4	4	40	■ T120M20008AA	273,80
200	10÷19,5	4	4	40	■ T120M20010AA	281,20
200	12÷23,5	4	4	40	■ T120M20012AA	273,80

Spec. T120M99

SPARE PARTS

Type	Dimensions	Per S	Code	€
Reversible knives	18X18X1,9	4	● C100M181819	7,10
Reversible knives	18X18X2,9	6	● C100M181829	10,60
Reversible knives	7,5X12X1,5	8	● C020M07512AA	2,00
Reversible knives	9,6X12X1,5	10	● C020M09612AA	2,40
Reversible knives	11,6X12X1,5	12	● C020M11612AA	4,70
Spur	14X14X1,2	4	● C040M14012AA	2,40
Spur	14X14X2	6-8-10-12	● C040M14020AA	2,40
Clamping wedge	6X10X10	8	● ETASS06	7,20
Clamping wedge	8X10X10	10	● ETASS08	8,10
Clamping wedge	10X10X10	12	● ETASS10	8,10
Screw c.e.r.	M4X3,2X6	4	● WV010	3,00
Screw c.e.r.	M4X4X6	6	● WV011	3,00
Spur screw	M5X6X9	8-10-12	● WV028	3,00
Knife screw	M5X12	8	● WV030	1,00
Knife screw	M6X12	10-12	● WV029	1,00
Spur ring nut	9,9X1,6XM4	4	● WG001	1,40
Spur ring nut	9,35X1,7XM4	6	● WG002	1,40
Knife ring nut	11,8X1,6XM4	4	● WG003	1,40
Knife ring nut	11,8X2,7XM4	6	● WG004	1,40
Screwdriver	Torx9	4-6	● ACHTC09AAAAA	9,40
Screwdriver	Torx20	8-10-12	● ACHTC20AAAAA	12,60
"T" allen key	Esag. 2,5	8	● ACHET25AAAAA	7,20
"T" allen key	Esag.3	10-12	● ACHET03AAAAA	7,40

NOTE

■ Utensili non a magazzino, quantità minima d'ordine: 2 pezzi.
Tools not ready in stock minimum order quantity: 2 pieces.

Il prezzo include coltelli, rasanti, anelli e 2 chiavi di regolazione.
The price included knives, spurs, spacing collars and 2 screwdrivers.

TAGLIO / SEZIONATURA
SAWING

DIAMANTE
DIAMOND

FRESATURA
CUTTING

PANTOGRAFATURA
ROUTING

FORATURA
BORING

MANDRINI / ATTACCHI
CHUCKS & CLAMPING SYSTEM

RICAMBI E LAVORAZIONI SUPP.
SPARE PARTS & ADD. WORKING

Teste portacoltelli per incastri sottili regolabili con anelli

Verstellbare Nut-Messerköpfe mit Distanzringe

Porte-outils à rainier extensible avec bagues de réglage

Регулируемые головки со сменными ножами для пазования



T122

HW Adjustable grooving cutterheads

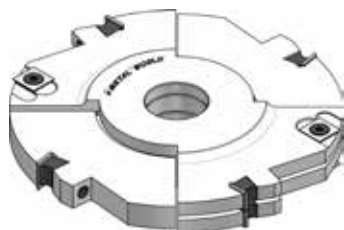

Costruite con corpo in acciaio bonificato • Coltelli e rasanti in HW a fissaggio meccanico • Ottima finitura • Indicate per l'esecuzione di scanalature di varie misure grazie alla regolazione mediante anelli distanziali • Da montare su macchine toupie, scorniciatrici, squadratrici etc.

Body in hardened and tempered steel • HW turnover knives and spurs • Excellent finish • Indicated for the execution of grooves of different thickness, regulation by means of spacer rings • Can be used on toupie, moulding machines, double end tenoner machines

● = Ready in stock ■ = Delivery time 20 working days △ = On request

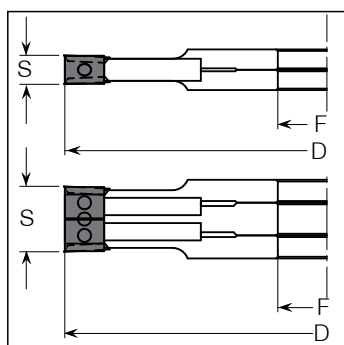

D	S	Z	V	F	Code	€
160	4÷7,5÷14	8+4	4	30	● T122M16004AA	387,00
160	6÷11÷20	8+4	4	30	● T122M16006AA	399,00
160	8÷15÷29	4+2	4	30	● T122M16008AA	380,00
160	10÷19,5÷39	4+2	4	30	● T122M16010AA	397,00
160	12÷23,5÷42	4+2	4	30	● T122M16012AA	397,00
200	4÷7,5÷14	8+4	4	40	■ T122M20004AA	409,00
200	6÷11÷20	8+4	4	40	■ T122M20006AA	421,00
200	8÷15÷29	4+2	4	40	■ T122M20008AA	407,00
200	10÷19,5÷39	4+2	4	40	■ T122M20010AA	414,00
200	12÷23,5÷42	4+2	4	40	■ T122M20012AA	414,00

Spec. T120M99

SPARE PARTS

Type	Dimensions	Per S	Code	€
Reversible knives	18X18X1,9	4	● C100M181819	7,10
Reversible knives	18X18X2,9	6	● C100M181829	10,60
Reversible knives	7,5X12X1,5	8	● C020M07512AA	2,00
Reversible knives	9,6X12X1,5	10	● C020M09612AA	2,40
Reversible knives	11,6X12X1,5	12	● C020M11612AA	4,70
Spur	14X14X1,2	4	● C040M14012AA	2,40
Spur	14X14X2	6-8-10-12	● C040M14020AA	2,40
Clamping wedge	6X10X10	8	● ETASS06	7,20
Clamping wedge	8X10X10	10	● ETASS08	8,10
Clamping wedge	10X10X10	12	● ETASS10	8,10
Screw c.e.r.	M4X3,2X6	4	● WV010	3,00
Screw c.e.r.	M4X4X6	6	● WV011	3,00
Spur screw	M5X6X9	8-10-12	● WV028	3,00
Knife screw	M5X12	8	● WV030	1,00
Knife screw	M6X12	10-12	● WV029	1,00
Spur ring nut	9,9X1,6XM4	4	● WG001	1,40
Spur ring nut	9,35X1,7XM4	6	● WG002	1,40
Knife ring nut	11,8X1,6XM4	4	● WG003	1,40
Knife ring nut	11,8X2,7XM4	6	● WG004	1,40
Screwdriver	Torx9	4-6	● ACHTC09AAAAA	9,40
Screwdriver	Torx20	8-10-12	● ACHTC20AAAAA	12,60
"T" allen key	Esag. 2,5	8	● ACHET25AAAAA	7,20
"T" allen key	Esag.3	10-12	● ACHET03AAAAA	7,60

NOTE

■ Utensili non a magazzino, quantità minima d'ordine: 2 pezzi.
Tools not ready in stock minimum order quantity: 2 pieces.

Il prezzo include coltelli, rasanti, anelli e 2 chiavi di regolazione.
The price included knives, spurs, spacing collars and 2 screwdrivers.

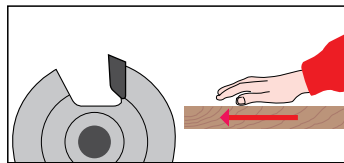
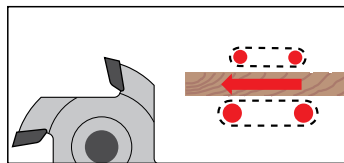
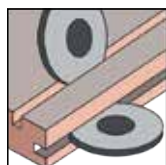
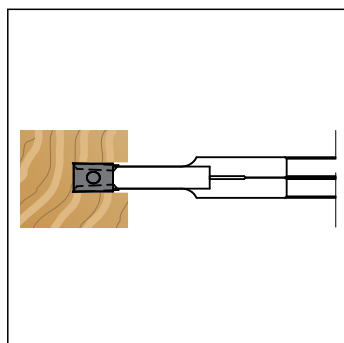

TAGLIO / SEZIONATURA
SAWING

DIAMANTE
DIAMOND

FRESATURA
CUTTING

PANTOGRAFATURA
ROUTING

FORATURA
BORING

MANDRINI / ATTACCHI
CHUCKS & CLAMPING SYSTEM

RICAMBI E LAVORAZIONI SUPP.
SPARE PARTS & ADD. WORKING



Teste portacoltelli per incastri regolabili con anelli per T122

Verstellbare Nut-Messerköpfe mit Distanzringe für T122

Porte-outils à rainer extensible avec bagues de réglage pour T122

Регулируемые головки со сменными ножами для пазования

TAGLIO / SEZIONATURA
SAWING

DIAMANTE
DIAMOND

FRESATURA
CUTTING

PANTOGRAFATURA
ROUTING

FORATURA
BORING

MANDRINI / ATTACCHI
CHUCKS & CLAMPING SYSTEM

RICAMBI E LAVORAZIONI SUPP.
SPARE PARTS & ADD. WORKING

T140

HW Central cutterhead for T122

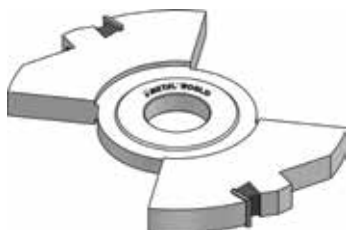

Costruite con corpo in acciaio bonificato • Coltelli e rasanti in HW a fissaggio meccanico • Ottima finitura • Indicate per l'esecuzione di scanalature di varie misure grazie alla regolazione mediante anelli distanziali • Da montare su macchine toupie, scorniciatrici, squadratrici etc.

Body in hardened and tempered steel • HW turnover knives and spurs • Excellent finish • Indicated for the execution of grooves of different thickness, regulation by means of spacer rings • Can be used on toupie, moulding machines, double and tenoner machines

Z=2

● = Ready in stock ■ = Delivery time 20 working days △ = On request

D	S	F	Code	€
160	7,5	30	■ T140M16075AA	133,40
200	7,5	40	■ T140M20075AA	147,60
160	15	30	■ T140M16015AA	142,80
200	15	40	■ T140M20015AA	154,80
160	20	30	■ T140M16020AA	147,60
200	20	40	■ T140M20020AA	154,80
160	30	30	■ T140M16030AA	152,40
200	30	40	■ T140M20030AA	159,60

Spec.			T140M99	
-------	--	--	---------	--

SPARE PARTS

Type	Dimensions	Code	€
Reversible knives	7,5X12X1,5	● C020M07512AA	2,00
Reversible knives	15X12X1,5	● C020M15012AA	2,40
Reversible knives	20X12X1,5	● C020M20012AA	2,80
Reversible knives	30X12X1,5	● C020M30012AB	3,40
Clamping wedge	6,8X15X16	● ETASS023227	12,00
Clamping wedge	12X10X10	● ETASS12	10,00
Clamping wedge	16X10X10	● ETASS16	10,40
Clamping wedge	26X10X10	● ETASS26	10,80
Clamping wedge's screw	M6X18	● WV033	3,00
Clamping wedge's screw	M8X16	● WV031	3,00
"T" allen key	Esag. 2,5	● ACHET25AAAAA	7,20
"T" allen key	Esag. 4	● ACHET04AAAAA	8,20

NOTE

■ Utensili non a magazzino, quantità minima d'ordine: **2 pezzi**.
Tools not ready in stock minimum order quantity: **2 pieces**.

Il prezzo include coltelli 1 chiave di regolazione.
The price included knives and 1 screwdriver.

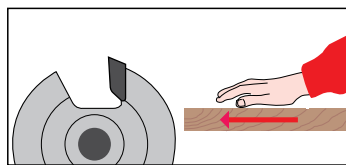
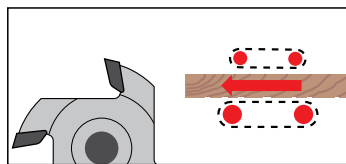
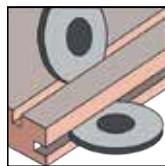
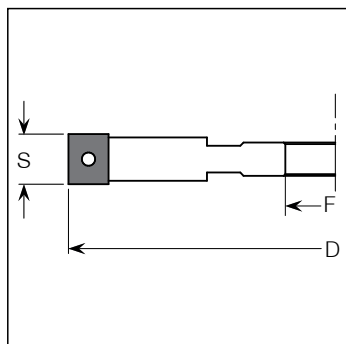

Teste portacoltelli per incastri regolabili con ghiera

Verstellbare Nut-Messerköpfe mit Vorschneider (Gewindebuchse)

Porte-outils à rainier extensible avec douille de réglage

Пазовые фрезы регулируемые градуированным кольцом



T130 HW Adjustable grooving cutterheads with threaded bush



Costruite con corpo in acciaio bonificato • Coltelli e rasanti in HW a fissaggio meccanico • Ottima finitura • Indicate per l'esecuzione di scanalature di diverso spessore • La regolazione avviene mediante ghiera filettata • Da montare su macchine toupie, scormiatrici, squadratrici etc.

Body in hardened and tempered steel • HW turnover knives and spurs • Excellent finish • Indicated for the execution of grooves of different thickness • Regulation by means of ring nut • Can be used on toupie, moulding machines

● = Ready in stock ■ = Delivery time 20 working days △ = On request

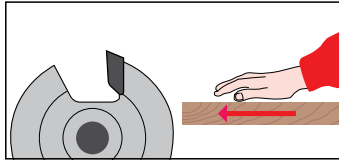
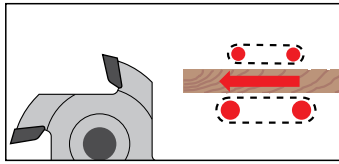
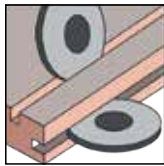
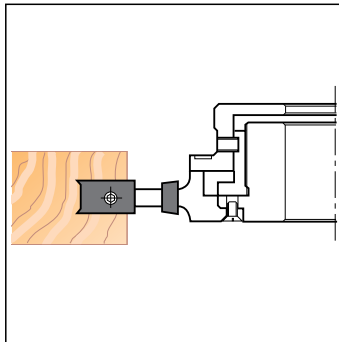
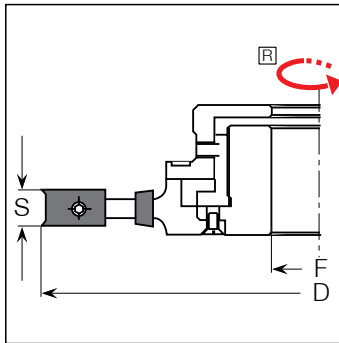

D	S	Z	V	F	Left Code	Right Code	€
160	4÷7,5	8	4	30	■ T130M16004AL	■ T130M16004AR	428,40
160	6÷11	8	4	30	■ T130M16006AL	■ T130M16006AR	437,20
160	8÷15	4	4	30	■ T130M16008AL	■ T130M16008AR	375,80
160	10÷19,5	4	4	30	■ T130M16010AL	■ T130M16010AR	387,40
160	12÷23,5	4	4	30	■ T130M16012AL	■ T130M16012AR	399,20
200	4÷7,5	8	4	40	■ T130M20004AL	■ T130M20004AR	445,80
200	6÷11	8	4	40	■ T130M20006AL	■ T130M20006AR	454,80
200	8÷15	4	4	40	■ T130M20008AL	■ T130M20008AR	387,40
200	10÷19,5	4	4	40	■ T130M20010AL	■ T130M20010AR	401,20
200	12÷23,5	4	4	40	■ T130M20012AL	■ T130M20012AR	412,80

Spec.	T130M99L	T130M99R

SPARE PARTS

Type	Dimensions	Per S	Code	€
Reversible knives	18X18X1,9	4	● C100M181819	7,10
Reversible knives	18X18X2,9	6	● C100M181829	10,60
Reversible knives	7,5X12X1,5	8	● C020M07512AA	2,00
Reversible knives	9,6X12X1,5	10	● C020M09612AA	2,40
Reversible knives	11,6X12X1,5	12	● C020M11612AA	4,70
Spur	14X14X1,2	4	● C040M14012AA	2,40
Spur	14X14X2	6-8-10-12	● C040M14020AA	2,40
Clamping wedge	6X10X10	8	● ETASS06	7,20
Clamping wedge	8X10X10	10	● ETASS08	8,10
Clamping wedge	10X10X10	12	● ETASS10	8,10
Screw c.e.r.	M4X3,2X6	4	● WV010	3,00
Screw c.e.r.	M4X4X6	6	● WV011	3,00
Spur screw	M5X6X9	8-10-12	● WV028	3,00
Knife screw	M5X12	8	● WV030	1,00
Knife screw	M6X12	10-12	● WV029	1,00
Spur ring nut	9,9X1,6XM4	4	● WG001	1,40
Spur ring nut	9,35X1,7XM4	6	● WG002	1,40
Knife ring nut	11,8X1,6XM4	4	● WG003	1,40
Knife ring nut	11,8X2,7XM4	6	● WG004	1,40
Screwdriver	Torx9	4-6	● ACHTC09AAAAA	9,40
"T" allen key	Esag, 2,5	8	● ACHET25AAAAA	7,20
"T" allen key	Esag, 3	10-12	● ACHET03AAAAA	7,40
"T" Torx key	Torx20	8-10-12	● ACHTT20AAAAA	14,80

NOTE

■ Utensili non a magazzino, quantità minima d'ordine: 2 pezzi.
Tools not ready in stock minimum order quantity: 2 pieces.

Il prezzo include coltelli, rasanti, anelli e 2 chiavi di regolazione.
The price included knives, spurs, spacing collars and 2 screwdrivers.

TAGLIO / SEZIONATURA
SAWING

DIAMANTE
DIAMOND

FRESATURA
CUTTING

PANTOGRAFATURA
ROUTING

FORATURA
BORING

MANDRINI / ATTACCHI
CHUCKS & CLAMPING SYSTEM

RICAMBI E LAVORAZIONI SUPP.
SPARE PARTS & ADD. WORKING

Teste portacoltelli per contornare

Füge-Messerköpfe mit Wendeplatten

Porte-outils à feullurer à coupes droites

Фрезы мультирадиусные для кромочных

T160

HW Jointing cutterheads with turnover knives



Costruite con corpo in acciaio bonificato • Coltelli in HW a fissaggio meccanico • Adatte per la contornatura di pannelli massicci, truciolari o in MDF, in base alla qualità del coltello montato • Da montare su macchine toupie, scorniciatrici, etc.

Body in hardened and tempered steel • HW turnover knives • Indicated for edging solid wood, chipboard and MDF panels based to the quality of the mounted knife • Can be used on toupie, moulding machines

● = Ready in stock ■ = Delivery time 20 working days △ = On request

D	S	Z	F	Code	€
100	30	2	30	■ T160M10030AA	110,00
100	50	2	30	■ T160M10050AA	126,60
125	30	2	30	■ T160M12530AA	116,00
125	50	2	30	■ T160M12550AA	133,40
125	30	4	30	● T160M12530BA	150,00
125	50	4	30	● T160M12550BA	174,40
140	50	4	30	■ T160M14050AA	180,20
180	50	4	40	■ T160M18050AA	201,60

Spec.				T160M99	
-------	--	--	--	---------	--

SPARE PARTS

Type	Dimensions	Code	€
Reversible knives	30X12X1,5	● C020M30012AB	3,40
Reversible knives	50X12X1,5	● C020M50012AB	4,60
Clamping wedge	26X10X10	● ETASS26	10,80
Clamping wedge	46X10X10	● ETASS46	14,40
Screw	M8X16	● WV031	3,00
"T" allen key	Esag. 4	● ACHET04AAAAA	8,20

NOTE

■ Utensili non a magazzino, quantità minima d'ordine: **2 pezzi.**
Tools not ready in stock minimum order quantity: **2 pieces.**

Il prezzo include coltelli, e 1 chiave di regolazione.
The price included knives and 1 screwdrivers.

Z2

RPM	Feed Speed
4000	4 m/min
5000	6 m/min
6000	8 m/min

Z4

RPM	Feed Speed
5000	16 m/min
6000	18 m/min
8000	22 m/min

The data are indicative only, MW is not responsible for any incorrect application

TAGLIO / SEZIONATURA
SAWING

DIAMANTE
DIAMOND

FRESATURA
CUTTING

PANTOGRAFATURA
ROUTING

FORATURA
BORING

MANDRINI / ATTACCHI
CHUCKS & CLAMPING SYSTEM

RICAMBI E LAVORAZIONI SUPP.
SPARE PARTS & ADD. WORKING

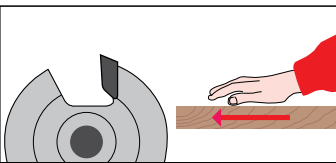
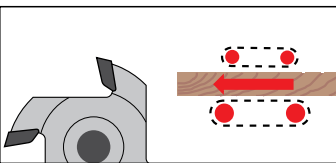
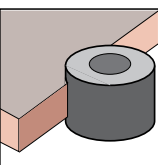
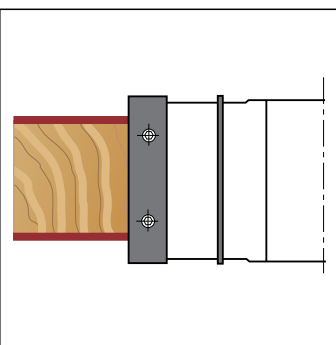
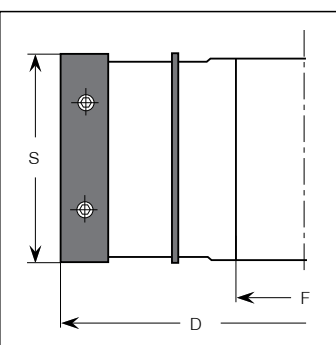

Teste portacoltelli per contornare con assiali alterni

Wendeplatte-Füge-Messerköpfe (Wechelseitigem Achswinkel)

Porte-outils pour dresser avec axial alterné

Фрезы для обгонки с переменными углами ножей



T174 HW Jointing cutterheads with turnover knives alternate shear

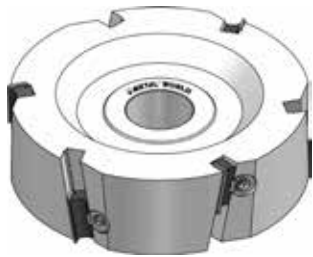

Costruite con corpo in acciaio bonificato • 3+3 coltelli in HW a fissaggio meccanico • Adatte per la contornatura di pannelli bilaminati melaminici o impiallacciati • Buona finitura dovuta all'assiale alternato, che riduce lo sforzo di lavorazione • Da montare su macchine toupie, scorniciatrici, squadratrici, etc.

Body in hardened and tempered steel • 3+3 HW turnover knives • Indicated for edging bi-laminated or veneered panels • The alternated axial grants a good finish and a reduction of the working stress • Can be used on toupie, moulding machines and double end tenoning machines

Z=3+3

● = Ready in stock ■ = Delivery time 20 working days △ = On request

D	S	F	Code	€
125	56	30	■ T174M12556AA	268,20
150	56	30	● T174M15056AA	282,20
180	56	40	■ T174M18056AA	311,00
Spec.			T174M99	

SPARE PARTS

Type	Dimensions	Code	€
Reversible knives	30X12X1,5	● C020M30012AB	3,40
Clamping wedge	26X13X10	● ETASS131026P	11,70
Screw	M10X22	● WV032	3,00
"T" allen key	Esag. 5	● ACHET05AAAAA	9,20

NOTE

■ Utensili non a magazzino, quantità minima d'ordine: **2 pezzi.**
Tools not ready in stock minimum order quantity: **2 pieces.**

Il prezzo include coltelli, e 1 chiave di regolazione.
The price included knives and 1 screwdrivers.

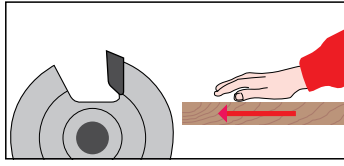
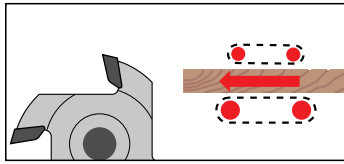
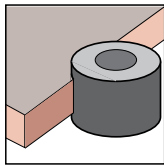
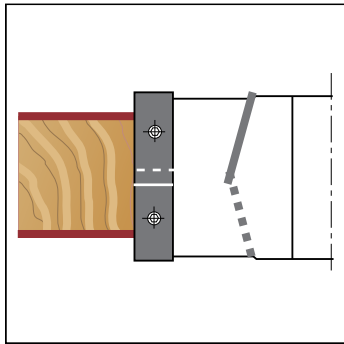
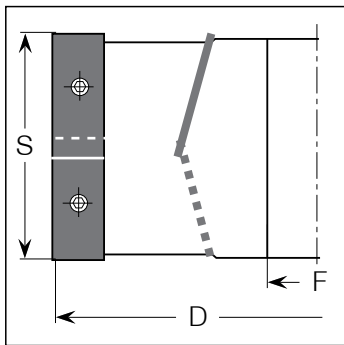

TAGLIO / SEZIONATURA
SAWING

DIAMANTE
DIAMOND

FRESATURA
CUTTING

PANTOGRAFATURA
ROUTING

FORATURA
BORING

MANDRINI / ATTACCHI
CHUCKS & CLAMPING SYSTEM

RICAMBI E LAVORAZIONI SUPP.
SPARE PARTS & ADD. WORKING



Teste portacoltelli
con rasanti
per battute regolabili



Wendeplatten Falz-
Messeköpfe, verstellbar



Porte-outils à feuillurer
extensible



Фрезы мультирадиусные
для кромочных

T180

HW Adjustable rebating cutterheads with turnover knives

TAGLIO / SEZIONATURA
SAWING

DIAMANTE
DIAMOND

FRESATURA
CUTTING

PANTOGRAFATURA
ROUTING

FORATURA
BORING

MANDRINI / ATTACCHI
CHUCKS & CLAMPING SYSTEM

RICAMBI E LAVORAZIONI SUPP.
SPARE PARTS & ADD. WORKING

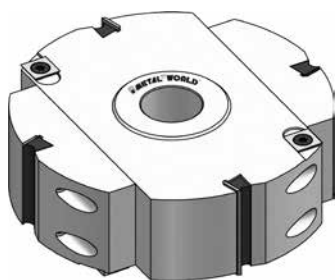

Costruite con corpo in acciaio bonificato • 4 coltelli e 4 rasanti in HW a fissaggio meccanico • Indicate per l'esecuzione di battute di diverso spessore • Buona finitura grazie ai rasanti • Da montare su macchine toupie, scorniciatrici, etc.

Body in hardened and tempered steel • 4 HW turnover knives and 4 spurs • Indicated for edging panels of different thickness • Regulation by means of collar spacers • Can be used on moulding machines and double end tenoning machines

Z=4 V=4

● = Ready in stock ■ = Delivery time 20 working days △ = On request

D	S	F	Code	€
160	20,5÷40	30	■ T180M16020AA	232,20
160	30,5÷60	30	■ T180M16030AA	277,40
160	50,5÷100	30	■ T180M16050AA	341,20
Spec.			T180M99	

SPARE PARTS

Type	Dimensions	Code	€
Reversible knife	20X12X1,5	● C020M20012AA	2,80
Reversible knife	30X12X1,5	● C020M30012AB	3,40
Reversible knife	50X12X1,5	● C020M50012AB	4,60
Spur	14X14X2	● C040M14020AA	2,40
Clamping wedge	16X10X10	● ETASS16	10,40
Clamping wedge	26X10X10	● ETASS26	10,80
Clamping wedge	46X10X10	● ETASS46	14,40
Spur screw	M5X8	● WV013	3,00
Screw	M8X16	● WV031	3,00
"T" allen key	Esag. 4	● ACHET04AAAAA	8,20
"T" Torx key	Torx20	● ACHTT20AAAAA	14,60

NOTE

■ Utensili non a magazzino, quantità minima d'ordine: 2 pezzi.
Tools not ready in stock minimum order quantity: 2 pieces.

Il prezzo include coltelli, rasanti, anelli e 2 chiavi di regolazione.
The price included knives, spurs, spacing collars and 2 screwdrivers.

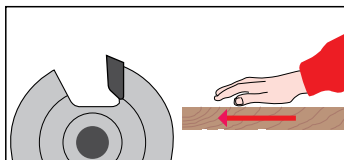
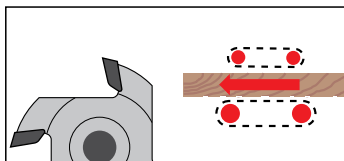
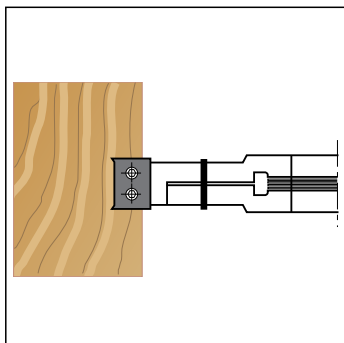
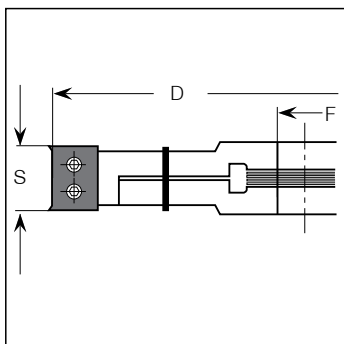



T182 HW Adjustable rebating cutterheads with turnover axial knives

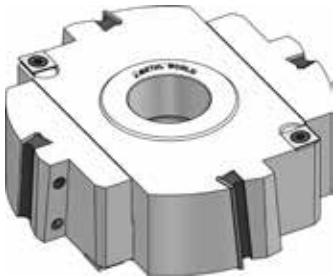

Costruite con corpo in acciaio bonificato • 4 coltelli e 4 rasanti HW a fissaggio meccanico • Indicate per l'esecuzione di battute di diverso spessore • La regolazione avviene mediante anelli distanziali • Buona finitura grazie ai rasanti e all'assiale, che riduce lo sforzo di lavorazione • Da montare su macchine toupie, scormiatrici, squadratrici etc.

Body in hardened and tempered steel • 4 HW turnover knives and 4 spurs • Indicated for edging panels of different thickness • Regulation by means of collar spacers • The alternated axial angle grants a good finish and reduces the working stress • Can be used on toupie, moulding machines and double end tenoning machines

Z=4 V=4

● = Ready in stock ■ = Delivery time 20 working days △ = On request

D	S	F	Code	€
160	20,5÷40	30	● T182M16020AA	379,80
160	30,5÷60	30	● T182M16030AA	451,80
160	50,5÷100	30	● T182M16050AA	553,00

Spec. T182M99

* Chiave ed anelli inclusi
* Allen key and spacers are included

SPARE PARTS

Type	Dimensions	Code	€
Reversible knife	20X12X1,5	● C020M20012AA	2,80
Reversible knife	30X12X1,5	● C020M30012AB	3,40
Reversible knife	50X12X1,5	● C020M50012AB	4,60
Spur	14X14X2	● C040M14020AA	2,40
Clamping wedge	16X10X10	● ETASS16	10,40
Clamping wedge	26X10X10	● ETASS26	10,80
Clamping wedge	46X10X10	● ETASS46	14,40
Spur screw	M5X8	● WV013	3,00
Screw	M8X16	● WV031	3,00
"T" allen key	Esag. 4	● ACHET04AAAAA	8,20
"T" Torx key	Torx20	● ACHTT20AAAAA	14,60

NOTE

■ Utensili non a magazzino, quantità minima d'ordine: 2 pezzi.
Tools not ready in stock minimum order quantity: 2 pieces.

Il prezzo include coltelli, rasanti, anelli e 2 chiavi di regolazione.
The price included knives, spurs, spacing collars and 2 screwdrivers.

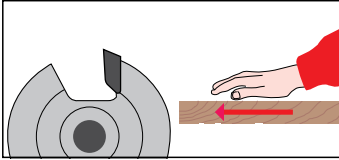
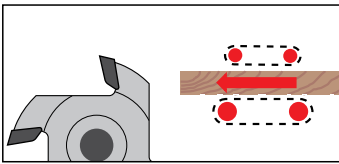
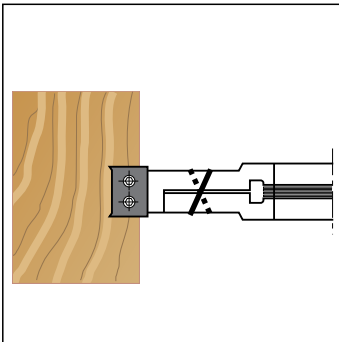
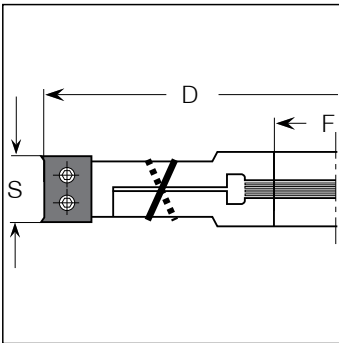

TAGLIO / SEZIONATURA
SAWING

DIAMANTE
DIAMOND

FRESATURA
CUTTING

PANTOGRAFATURA
ROUTING

FORATURA
BORING

MANDRINI / ATTACCHI
CHUCKS & CLAMPING SYSTEM

RICAMBI E LAVORAZIONI SUPP.
SPARE PARTS & ADD. WORKING

Teste portacoltelli
con rasanti
per battute

Falz-Messerköpfe
mit Vorschneider

Porte-outils à feullurer
avec araseurs

Фрезы для четверти с
подрезными ножами

T190

HW Rebating cutterheads with turnover knives

TAGLIO / SEZIONATURA
SAWING

DIAMANTE
DIAMOND

FRESATURA
CUTTING

PANTOGRAFATURA
ROUTING

FORATURA
BORING

MANDRINI / ATTACCHI
CHUCKS & CLAMPING SYSTEM

RICAMBI E LAVORAZIONI SUPP.
SPARE PARTS & ADD. WORKING

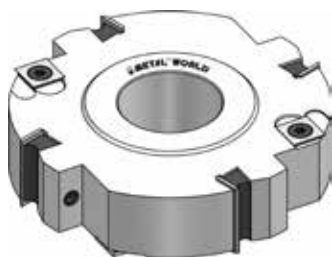

Costruite con corpo in acciaio bonificato • Coltelli e rasanti HW a fissaggio meccanico • Indicate per l'esecuzione di battute superiori o inferiori • Adatte per lavorare legni massici • Buona finitura grazie alla presenza di rasanti • Da montare su macchine toapie, scorniciatrici

Body in hardened and tempered steel • HW turnover knives and knives • Indicated for rebating top and/or bottom side of panels • Suitable for working solid wood • The spurs grant a good finish • Can be used on toupie, moulding machines and double end tenoning machines

● = Ready in stock ■ = Delivery time 20 working days △ = On request

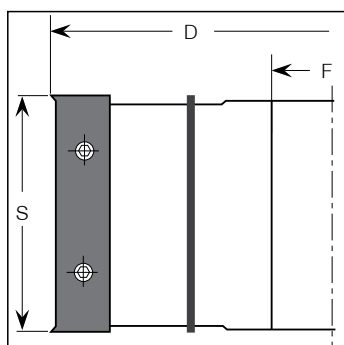

D	S	Z	V	F	Code	€
100	30	2	4	30	■ T190M10030AA	177,20
100	50	2	4	30	■ T190M10050AA	201,60
125	30	2	4	30	■ T190M12530AA	191,20
125	50	2	4	30	■ T190M12550AA	219,20
125	30	4	4	30	● T190M12530BA	206,20
125	50	4	4	30	● T190M12550BA	226,00
140	50	4	4	30	■ T190M14050AA	231,80
180	50	4	4	40	■ T190M18050AA	250,00

Spec.					T190M99	
-------	--	--	--	--	---------	--

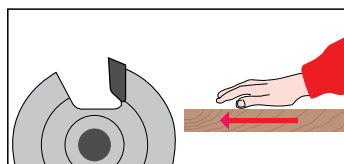
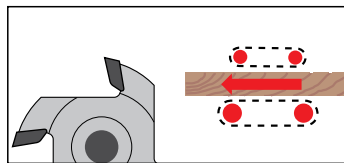
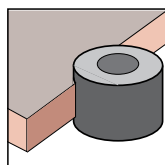
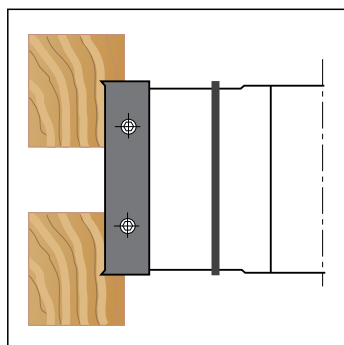

SPARE PARTS

Type	Dimensions	Code	€
Reversible knives	30X12X1,5	● C020M30012AB	3,40
Reversible knives	50X12X1,5	● C020M50012AB	4,60
Spur	14X14X2	● C040M14020AA	2,40
Clamping wedge	26X10X10	● ETASS26	10,80
Clamping wedge	46X10X10	● ETASS46	14,40
Spur screw	M5X8	● WV013	3,00
Screw	M8X16	● WV031	3,00
"T" allen key	Esag. 4	● ACHET04AAAAA	8,20
"T" Torx key	Torx20	● ACHTT20AAAAA	14,60

NOTE

■ Utensili non a magazzino, quantità minima d'ordine: **2 pezzi.**
Tools not ready in stock minimum order quantity: **2 pieces.**

Il prezzo include coltelli, rasanti e 2 chiavi di regolazione.
The price included knives, spurs and 2 screwdrivers.



T192 HW Rebating cutterheads with turnover knives alternate shear

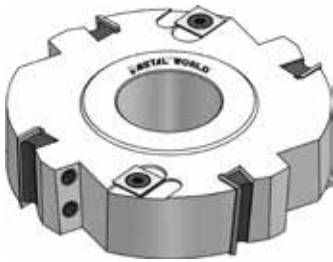

Costruite con corpo in acciaio bonificato • Coltelli e rasanti in HW a fissaggio meccanico • Indicate per l'esecuzione di battute superiori o inferiori • Buona finitura grazie alla presenza di rasanti e all'assiale alterno • Da montare su macchine toupie, scorniciatrici

Body in hardened and tempered steel • HW turnover knives and spurs • Indicated for rebating top and/or bottom side of panels • Suitable for working solid wood • The alternated axial and the spurs grant a good finish • Can be used on toupie, moulding machines and double end tenoning machines

● = Ready in stock ■ = Delivery time 20 working days △ = On request

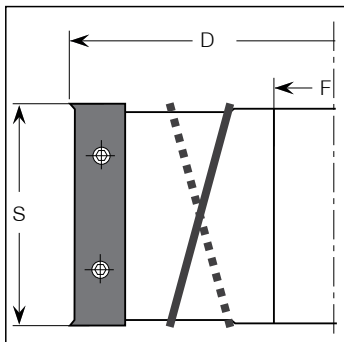

D	S	Z	V	F	Code	€
125	30	2	4	30	● T192M12530AA	186,20
125	50	2	4	30	● T192M12550AA	204,60
125	30	4	4	30	● T192M12530BA	195,40
125	50	4	4	30	● T192M12550BA	220,20
140	50	4	4	30	■ T192M14050AA	255,00
180	50	4	4	40	■ T192M18050AA	275,60
Spec.					T192M99	

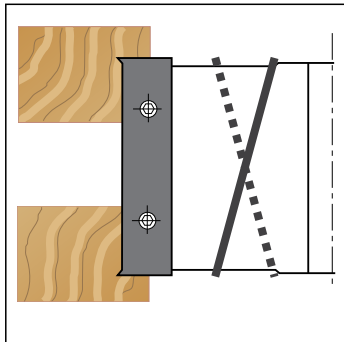

SPARE PARTS

Type	Dimensions	Code	€
Reversible knives	30X12X1,5	● C020M30012AB	3,40
Reversible knives	50X12X1,5	● C020M50012AB	4,60
Spur	14X14X2	● C040M14020AA	2,40
Clamping wedge	26X10X10	● ETASS26	10,80
Clamping wedge	46X10X10	● ETASS46	14,40
Spur screw	M5X8	● WV013	3,00
Screw	M8X16	● WV031	3,00
"T" allen key	Esag. 4	● ACHETO4AAAAA	8,20
"T" Torx key	Torx20	● ACHTT20AAAAA	14,60

NOTE

■ Utensili non a magazzino, quantità minima d'ordine: 2 pezzi.
Tools not ready in stock minimum order quantity: 2 pieces.

Il prezzo include coltelli, rasanti e 2 chiavi di regolazione.
The price included knives, spurs and 2 screwdrivers.

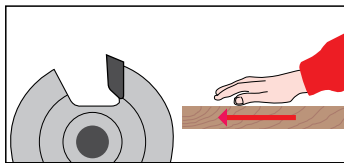
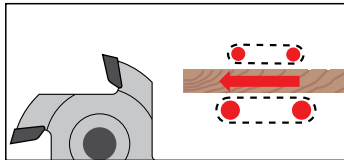
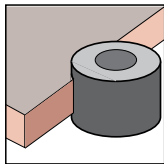

TAGLIO / SEZIONATURA
SAWING

DIAMANTE
DIAMOND

FRESATURA
CUTTING

PANTOGRAFATURA
ROUTING

FORATURA
BORING

MANDRINI / ATTACCHI
CHUCKS & CLAMPING SYSTEM

RICAMBI E LAVORAZIONI SUPP.
SPARE PARTS & ADD. WORKING

Teste portacoltelli
in lega leggera
per DEKING

Messerköpfe für DEKING

Porte-outils pour DEKING
en alliage
à raboter coupe hélicoïdal

Легкосплавные
фрезерные головки для
DEKING

T195

HW DEKING multiteeth jointing cutterheads in light alloy

TAGLIO / SEZIONATURA
SAWING

DIAMANTE
DIAMOND

FRESATURA
CUTTING

PANTOGRAFATURA
ROUTING

FORATURA
BORING

MANDRINI / ATTACCHI
CHUCKS & CLAMPING SYSTEM

RICAMBI E LAVORAZIONI SUPP.
SPARE PARTS & ADD. WORKING



Costruite in lega leggera • Coltelli in HW a fissaggio meccanico • Indicate per piccole asportazioni • Da montare su macchine scorticatrici in generale

Body in light alloy • HW turnover knives • Indicated for small chip removal • Can be used on moulding machines

● = Ready in stock ■ = Delivery time 20 working days △ = On request

D	S	Div.	Z	Radius Spurs	F	Code	€
140	79,5	6	9	6	40	■ T195M1400795	1.347,60
140	129,5	6	15	6	40	■ T195M1401295	1.460,20
140	179,5	6	21	6	40	■ T195M1401795	1.613,60
140	229,5	6	27	6	40	■ T195M1402295	1.827,80

SPARE PARTS

Type	Dimensions	Code	€
Profiled knives	29,5X11,5X1,5 ●	C025MS022258	19,20
Profiled knives	29,5X11,5X1,5 ●	C025MS022259	19,20
Profiled knives	29,5X11,5X1,5 ●	C025MS022260	19,20
Reversible knives	29,5X10X1,5 ●	C025MS022254	6,40
Clamping wedge	26X13X10 ●	ETASS131026P	11,70
Ogive	15X13,5XM10SX ●	WOG01	5,40
Screw	M10X22 ●	WV032	3,00
Support for rounding insert right	25X20X17 ●	SUPPSMUSDO199923	43,20
Support for rounding insert left	25X20X17 ●	SUPPSMUSDO199925	43,20
Screws for rounding inserts	M6X15 ●	WV040	3,00
"T" allen key	Esag. 5 ●	ACHET05AAAAA	9,20

NOTE

■ Utensili non a magazzino, quantità minima d'ordine: **1 pezzo.**
Tools not ready in stock minimum order quantity: **1 piece.**

Il prezzo include coltelli e 1 chiave di regolazione.
The price included knives and 1 screwdriver.

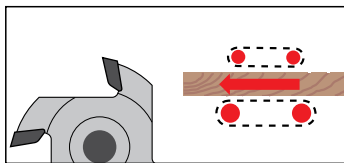
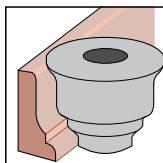
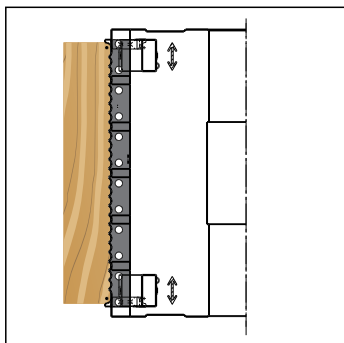
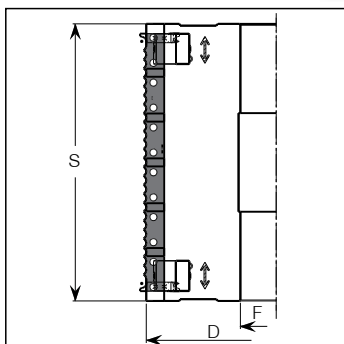



T198 HW Multiteeth jointing cutterheads in light alloy

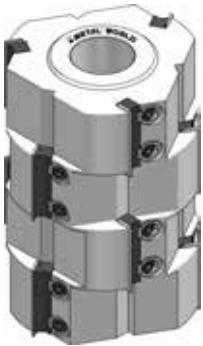

Costruite in lega leggera • Coltelli in HW a fissaggio meccanico • Indicate per piccole asportazioni • Da montare su macchine scorniciatrici in generale

Body in light alloy • HW turnover knives • Indicated for small chip removal • Can be used on moulding machines

TAGLIO / SEZIONATURA
SAWING

DIAMANTE
DIAMOND

FRESATURA
CUTTING

PANTOGRAFATURA
ROUTING

FORATURA
BORING

MANDRINI / ATTACCHI
CHUCKS & CLAMPING SYSTEM

RICAMBI E LAVORAZIONI SUPP.
SPARE PARTS & ADD. WORKING

3 PRINCIPLES CUTTING

● = Ready in stock ■ = Delivery time 20 working days △ = On request

D	S	Div.	Z	F	Code	€
125	94	6	6	40	■ T198M125094C	307,60
125	138	6	9	40	■ T198M125138C	434,20
125	182	6	12	40	■ T198M125182C	545,20
125	226	6	15	40	■ T198M125226C	644,40
140	94	6	6	40	■ T198M140094C	319,40
140	138	6	9	40	■ T198M140138C	451,80
140	182	6	12	40	■ T198M140182C	568,60
140	226	6	15	40	■ T198M140226C	669,80
Spec.					T198M99	

SPARE PARTS

Type	Dimensions	Code	€
Reversible knives	50X12X1,5	● C028M05012AB	7,00
Clamping wedge	46X13X10	● ETASS131046P	14,40
Ogive cl. syst.	15X13,5XM10SX	● WOG01	5,40
Screw	M10X22	● WV032	3,00
"T" allen key	Esag.5	● ACHET05AAAAA	9,20

NOTE

■ Utensili non a magazzino, quantità minima d'ordine: **1 pezzo.**
Tools not ready in stock minimum order quantity: **1 piece.**

Il prezzo include coltelli e 1 chiave di regolazione.
The price included knives and 1 screwdriver.

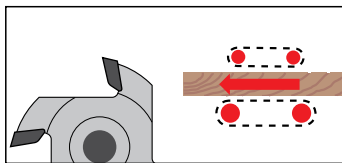
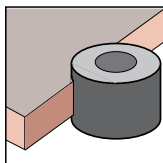
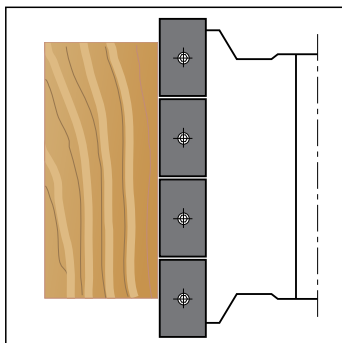
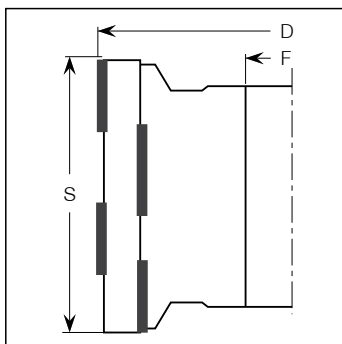

Teste hydro portacoltelli
in lega leggera
per piallare

Hydro Wendepplatten -
Hobel Messerkopf

Porte-outils en alliage
à raboter avec hydro

Легкосплавные
фрезерные головки
гидро для строгания

T198H

HW Hydro multiteeth jointing cutterheads in light alloy

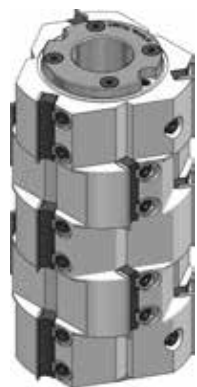

Costruite in lega leggera • Coltelli in HW a fissaggio meccanico • Sistema hydro per un perfetto accoppiamento tra l'utensile e l'albero macchina • L'elevata precisione della concentricità dei taglienti consente un maggior avanzamento e una migliore finitura • Indicate per piccole asportazioni • Da montare su macchine scorniciatrici in generale

Body in light alloy • HW turnover knives • Hydro bush system for a perfect joint between the tool and the spindle of the machine • The accuracy of concentricity of the cutting edges allows for greater feed speed and a better finish • Indicated for reduced chip removal • Can be used on moulding machines

3 PRINCIPLES CUTTING

● = Ready in stock ■ = Delivery time 20 working days △ = On request

D	S	Div.	Z	F	Code Type A	Code Type B	€
125	94	6	6	40	■ T198M125094A	■ T198M125094B	786,60
125	138	6	9	40	■ T198M125138A	■ T198M125138B	959,80
125	182	6	12	40	■ T198M125182A	■ T198M125182B	1.165,20
125	226	6	15	40	■ T198M125226A	■ T198M125226B	1.315,00
140	94	6	6	40	■ T198M140094A	■ T198M140094B	797,20
140	138	6	9	40	■ T198M140138A	■ T198M140138B	974,40
140	182	6	12	40	■ T198M140182A	■ T198M140182B	1.186,60
140	226	6	15	40	■ T198M140226A	■ T198M140226B	1.338,40

Spec.	T198M99	T198M99

SPARE PARTS

Type	Dimensions	Code	€
Reversible knife	50X12X1,5	● C028M05012AB	7,00
Clamping wedge	46X13X10	● ETASS131046P	14,40
Ogive cl. syst.	15X13,5XM10SX	● WOG01	5,40
Screw	M10X22	● WV032	3,00
"T" allen key	Esag.5	● ACHET05AAAAA	9,20
Hydro pump		● WAGREASEPUMP	940,40

NOTE

■ Utensili non a magazzino, quantità minima d'ordine: **1 pezzo.**
Tools not ready in stock minimum order quantity: **1 piece.**

Il prezzo include coltelli e 1 chiave di regolazione.
The price included knives and 1 screwdriver.

GREASE GUN TYPES

Frontal grease gun
TYPE A

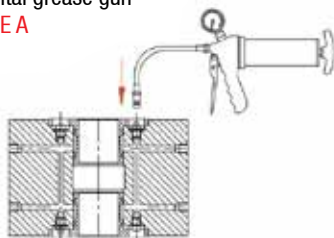

GREASE GUN TYPES

Lateral grease gun
TYPE B

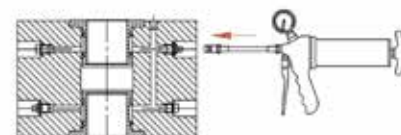

TAGLIO / SEZIONATURA
SAWING

DIAMANTE
DIAMOND

FRESATURA
CUTTING

PANTOGRAFATURA
ROUTING

FORATURA
BORING

MANDRINI / ATTACCHI
CHUCKS & CLAMPING SYSTEM

RICAMBI E LAVORAZIONI SUPP.
SPARE PARTS & ADD. WORKING



T200 HW Multiteeth jointing cutterheads

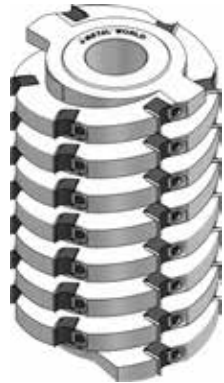

Costruite con corpo in acciaio bonificato • Coltelli in HW a fissaggio meccanico • La forma elicoidale e gli ampi scarichi diminuiscono l'assorbimento di potenza e la rumorosità ed aumentano la durata degli utensili • Indicate per lavorazioni di contornatura di legni curvati • Utilizzabili anche su macchine scorniciatrici e toupie

Body in hardened and tempered steel • HW turnover knives • The large spiral execution reduces the electrical input and the noise and increases the tool life • Suitable for working curved panels • Can be used on moulding machines and toupie

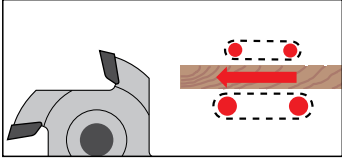
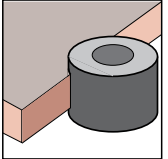
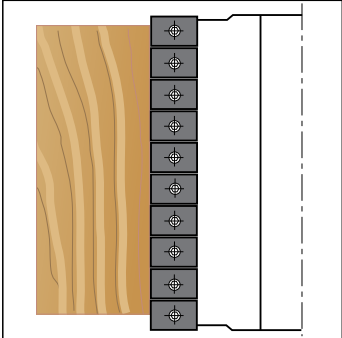
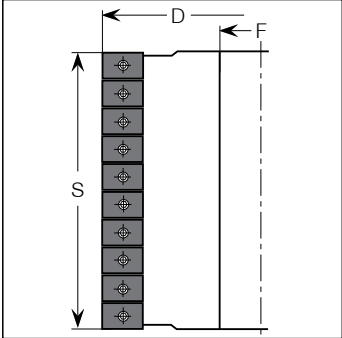

2 CUTTING PRINCIPLES

● = Ready in stock ■ = Delivery time 20 working days △ = On request

D	S	Div.	Z	F	Code F 35	Code F 40	€
120	84	6	20	40	■ T200M120084A	■ T200M120084C	418,80
120	100	6	24	40	■ T200M120100A	■ T200M120100C	462,60
120	124	6	30	40	■ T200M120124A	■ T200M120124C	526,60
120	140	6	34	40	■ T200M120140A	■ T200M120140C	571,20
120	164	6	40	40	■ T200M120164A	■ T200M120164C	634,40
120	180	6	44	40	■ T200M120180A	■ T200M120180C	679,00
140	84	6	20	40	■ T200M140084A	■ T200M140084C	432,00
140	100	6	24	40	■ T200M140100A	■ T200M140100C	476,60
140	124	6	30	40	■ T200M140124A	■ T200M140124C	539,80
140	140	6	34	40	■ T200M140140A	■ T200M140140C	584,40
140	164	6	40	40	■ T200M140164A	■ T200M140164C	650,20
140	180	6	44	40	■ T200M140180A	■ T200M140180C	694,00
120	84	8	26	40	■ T200M120084B	■ T200M120084D	496,00
120	102	8	32	40	■ T200M120102B	■ T200M120102D	565,20
120	120	8	38	40	■ T200M120120B	■ T200M120120D	632,60
120	144	8	46	40	■ T200M120144B	■ T200M120144D	722,80
120	162	8	52	40	■ T200M120162B	■ T200M120162D	792,80
120	180	8	58	40	■ T200M120180B	■ T200M120180D	860,40
140	84	8	26	40	■ T200M140084B	■ T200M140084D	509,00
140	102	8	32	40	■ T200M140102B	■ T200M140102D	582,60
140	120	8	38	40	■ T200M140120B	■ T200M140120D	653,60
140	144	8	46	40	■ T200M140144B	■ T200M140144D	750,00
140	162	8	52	40	■ T200M140162B	■ T200M140162D	823,60
140	180	8	58	40	■ T200M140180B	■ T200M140180D	894,60

Spec.					T200M99	T200M99	
-------	--	--	--	--	---------	---------	--

SPARE PARTS

Type	Dimensions	Code	€
Reversible knife	12X12X1,5	● C020M12012AA	2,20
Clamping wedge	10X13X10	● ETASS131010P	10,80
Screw	M6X18	● WV033	3,00
Ogive clamp. sys.	10X11,5XM6SX	● WOG04	4,50
"T" allen key	Esag. 3	● ACHET03AAAAA	7,60
"T" allen key	Esag. 5	● ACHET05AAAAA	9,20

NOTE
 ■ Utensili non a magazzino, quantità minima d'ordine: 1 pezzo.
 Tools not ready in stock minimum order quantity: 1 piece.

Il prezzo include coltelli e 1 chiave di regolazione.
 The price included knives and 1 screwdriver.

TAGLIO / SEZIONATURA SAWING
 DIAMANTE DIAMOND
 FRESATURA CUTTING
 PANTOGRAFATURA ROUTING
 FORATURA BORING
 MANDRINI / ATTACCHI CHUCKS & CLAMPING SYSTEM
 RICAMBI E LAVORAZIONI SUPP. SPARE PARTS & ADD. WORKING

Teste portainseri multitaglienti per piallare

Spiral-Hobel-Messerköpfe

Porte-outils à calibrer a coupe hélicoïdal

Фрезерные головки со сменными резцами для строгания

T201

HW Multiteeth jointing cutterheads

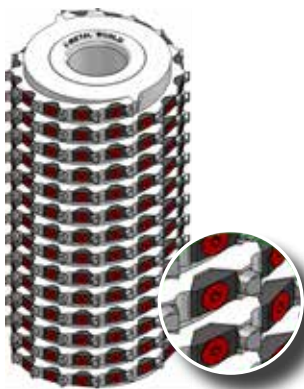

Costruite con corpo in acciaio bonificato • Inserti in HW integrale a fissaggio meccanico • Predisposte per accoppiamenti modulari • La forma elicoidale e gli ampi scarichi diminuiscono l'assorbimento di potenza e la rumorosità ed aumentano la durata degli utensili • Indicate per grosse asportazioni • Ideale per lavorazioni di contornatura di legni curvati • Utilizzabili anche su macchine scorniciatrici e toupie

Body in hardened and tempered steel • Turnover knives in solid carbide • Set up for modular couplings • The large spiral execution reduces the electrical input and the noise and increases the tool life • Suitable for big chip removal • Indicated to work curved panels • Can be used on moulding machines and toupie

● = Ready in stock ■ = Delivery time 20 working days △ = On request

D	S	Div.	Z	F	Code	€
125	80	16	76	40	△ T201M125080C	874,00
125	100	16	96	40	△ T201M125100C	1.104,00
125	120	16	116	40	△ T201M125120C	1.334,00
125	140	16	136	40	△ T201M125140C	1.564,00
125	160	16	156	40	△ T201M125160C	1.794,00
125	180	16	176	40	△ T201M125180C	2.024,00
125	200	16	196	40	△ T201M125200C	2.254,00
125	240	16	236	40	△ T201M125240C	2.714,00

Spec. T201M99

SPARE PARTS

Type	Dimensions	Code	€
HWM insert	7X12	● WITR05HWMAAA	10,00
Screw	M4X12	● WV071	3,50
"T" Torx key	Torx20	● ACHTT20AAAAA	14,60

NOTE

■ Utensili non a magazzino, quantità minima d'ordine: **1 pezzo.**
Tools not ready in stock minimum order quantity: **1 piece.**

Il prezzo include coltelli e 1 chiave di regolazione.
The price included knives and 1 screwdriver.

TAGLIO / SEZIONATURA
SAWING

DIAMANTE
DIAMOND

FRESATURA
CUTTING

PANTOGRAFATURA
ROUTING

FORATURA
BORING

MANDRINI / ATTACCHI
CHUCKS & CLAMPING SYSTEM

RICAMBI E LAVORAZIONI SUPP.
SPARE PARTS & ADD. WORKING

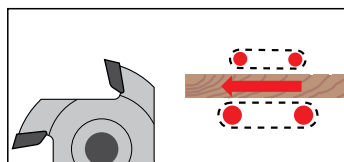
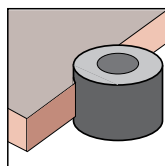
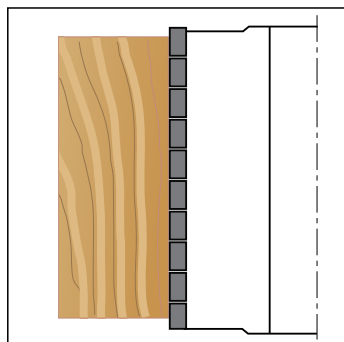
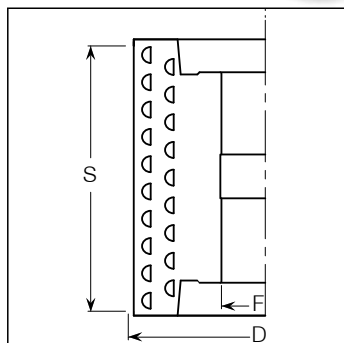



T202

HW Spiral jointing cutterheads in light alloy

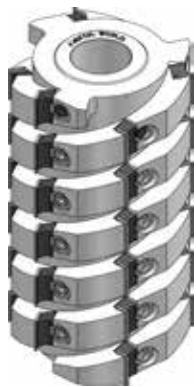

Costruite con corpo in lega leggera • Coltelli in HW a fissaggio meccanico • 6 divisioni • La forma elicoidale e gli ampi scarichi diminuiscono l'assorbimento di potenza, la rumorosità ed aumentano la durata degli utensili • Indicate per medie asportazioni • Da montare su macchine scorniciatrici

Body in light alloy • HW turnover knives • 6 divisions • The large spiral execution reduces the electrical input and the noise and increases the tool life • Suitable for medium chip removal • Indicated to work curved panels • Can be used on moulding machines and toupie

3 CUTTING PRINCIPLES

● = Ready in stock ■ = Delivery time 20 working days △ = On request

D	S	Div.	Z	F	Code	
125	78	6	12	40	■ T202M125078C	300,40
125	96	6	15	40	■ T202M125096C	289,60
125	114	6	18	40	■ T202M125114A	332,00
125	132	6	21	40	■ T202M125132A	373,40
125	150	6	24	40	■ T202M125150C	415,80
125	168	6	27	40	■ T202M125168C	457,20
125	186	6	30	40	■ T202M125186C	498,20
125	204	6	33	40	■ T202M125204C	538,40
125	222	6	36	40	■ T202M125222C	562,40
125	240	6	39	40	■ T202M125240C	601,40

Spec.					T202M99	
-------	--	--	--	--	---------	--

SPARE PARTS

Type	Dimensions	Code	€
Reversible knife	24X12X1,5	● C028M02412AA	5,20
Clamping wedge	20X13X10	● ETASS13102015	10,80
Ogive clamp. sys.	15X13,5XM10sx	● WOG01	5,40
Screw	M10X22	● WV032	3,00
"T" allen key	Esag. 5	● ACHET05AAAAA	9,20

NOTE

■ Utensili non a magazzino, quantità minima d'ordine: **1 pezzo.**
Tools not ready in stock minimum order quantity: **1 piece.**

Il prezzo include coltelli e 1 chiave di regolazione.
The price included knives and 1 screwdriver.

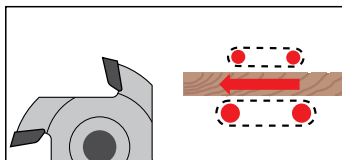
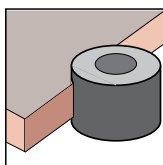
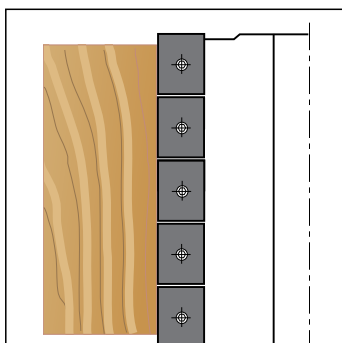
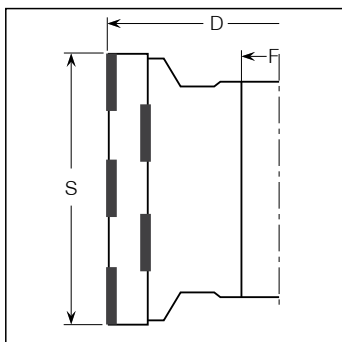

TAGLIO / SEZIONATURA
SAWING

DIAMANTE
DIAMOND

FRESATURA
CUTTING

PANTOGRAFATURA
ROUTING

FORATURA
BORING

MANDRINI / ATTACCHI
CHUCKS & CLAMPING SYSTEM

RICAMBI E LAVORAZIONI SUPP.
SPARE PARTS & ADD. WORKING



Teste hydro portacoltelli elicoidali in lega leggera per piallare

Hydro Spiral-Hobel-Messerköpfe

Porte-outils en alliage à raboter coupe hélicoïdal avec hydro

Фрезерные головки гидро со сменными ножами для строгания

TAGLIO / SEZIONATURA SAWING

DIAMANTE DIAMOND

FRESATURA CUTTING

PANTOGRAFATURA ROUTING

FORATURA BORING

MANDRINI / ATTACCHI CHUCKS & CLAMPING SYSTEM

RICAMBI E LAVORAZIONI SUPP. SPARE PARTS & ADD. WORKING

T202H

HW Hydro jointing cutterheads in light alloy



Costruite con corpo in lega leggera • Coltelli in HW a fissaggio meccanico • 6 divisioni • Il sistema hydro consente un perfetto accoppiamento tra l'utensile e l'albero macchina • La forma elicoidale e gli ampi scarichi diminuiscono l'assorbimento di potenza ed aumentano la durata degli utensili • L'elevata precisione della concentricità dei taglienti consente un maggior avanzamento e una migliore finitura • Indicate per medie asportazioni • Da montare su macchine scorniciatrici

Body in light alloy • HW turnover knives • 6 divisions • Hydro bush system for a perfect joint between the tool and the spindle of the machine • The large spiral execution reduces the electrical input and the noise and increases the tool life • The accuracy of concentricity of the cutting edges allows for greater feed speed and a better finish • Suitable for medium chip removal • Indicated to work curved panels • Can be used on moulding machines

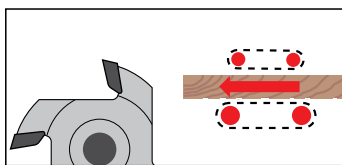
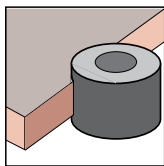
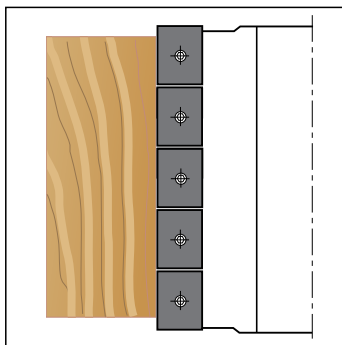
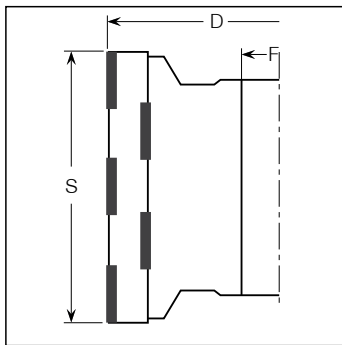

3 CUTTING PRINCIPLES

● = Ready in stock ■ = Delivery time 20 working days △ = On request

D	S	Z	F	Code Type A	Code Type B	€
143	78	12	40	■ T202M143078A	■ T202M143078B	732,40
143	96	15	40	■ T202M143096A	■ T202M143096B	828,80
143	114	18	40	■ T202M143114A	■ T202M143114B	910,20
143	132	21	40	■ T202M143132A	■ T202M143132B	989,20
143	150	24	40	■ T202M143150A	■ T202M143150B	1.085,40
143	168	27	40	■ T202M143168A	■ T202M143168B	1.170,40
143	186	30	40	■ T202M143186A	■ T202M143186B	1.243,20
143	204	33	40	■ T202M143204A	■ T202M143204B	1.328,20
143	222	36	40	■ T202M143222A	■ T202M143222B	1.401,80
143	240	39	40	■ T202M143240A	■ T202M143240B	1.474,40
163	78	12	40	■ T202M163078A	■ T202M163078B	750,00
163	96	15	40	■ T202M163096A	■ T202M163096B	846,40
163	114	18	40	■ T202M163114A	■ T202M163114B	931,40
163	132	21	40	■ T202M163132A	■ T202M163132B	1.014,60
163	150	24	40	■ T202M163150A	■ T202M163150B	1.110,80
163	168	27	40	■ T202M163168A	■ T202M163168B	1.199,40
163	186	30	40	■ T202M163186A	■ T202M163186B	1.276,40
163	204	33	40	■ T202M163204A	■ T202M163204B	1.363,20
163	222	36	40	■ T202M163222A	■ T202M163222B	1.438,60
163	240	39	40	■ T202M163240A	■ T202M163240B	1.515,60

Spec.	T202M99	T202M99
-------	---------	---------

SPARE PARTS

Type	Dimensions	Code	€
Reversible knife	24X12X1,5	● C028M02412AA	5,20
Clamping wedge	20X13X10	● ETASS13102015	10,80
Ogive clamp. sys.	15X13,5XM10sx	● WOG01	5,40
Screw	M10X22	● WV032	3,00
Screw	Esag. 5	● ACHET05AAAAA	9,20
Pompa Hydro		● WGREASEPUMP	940,40

NOTE

■ Utensili non a magazzino, quantità minima d'ordine: **1 pezzo.**
Tools not ready in stock minimum order quantity: **1 piece.**

Il prezzo include coltelli e 1 chiave di regolazione.
The price included knives and 1 screwdriver.

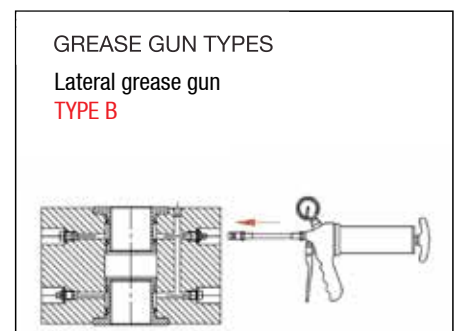
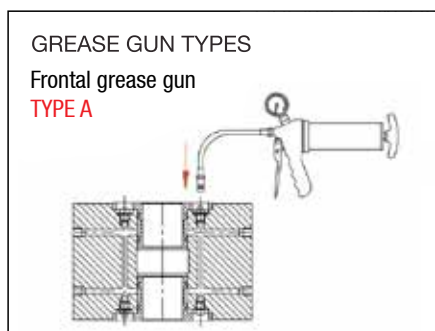



T203 HW Axial spiral jointing cutterheads in light alloy



Costruite con corpo in lega leggera • Coltelli in HW a fissaggio meccanico • 6 divisioni • La forma elicoidale e gli ampi scarichi diminuiscono l'assorbimento di potenza, la rumorosità ed aumentano la durata degli utensili • La disposizione assiale dei denti permette una migliore finitura • Indicate per medie asportazioni • Da montare su macchine scorniciatrici

Body in light alloy • HW turnover knives • 6 divisions • The large spiral execution reduces the electrical input and the noise and increases the tool life • Suitable for medium chip removal • Indicated to work curved panels • Can be used on moulding machines and toupie

3 CUTTING PRINCIPLES

● = Ready in stock ■ = Delivery time 20 working days △ = On request

D	S	Div.	Z	F	Code	€
125	78	6	12	40	■ T203M125078C	458,60
125	96	6	15	40	■ T203M125096C	538,40
125	114	6	18	40	■ T203M125114C	615,20
125	132	6	21	40	■ T203M125132C	692,20
125	150	6	24	40	■ T203M125150C	771,00
125	168	6	27	40	■ T203M125168C	850,80
125	186	6	30	40	■ T203M125186C	925,80
125	204	6	33	40	■ T203M125204C	1.000,80
125	222	6	36	40	■ T203M125222C	1.075,60
125	240	6	39	40	■ T203M125240C	1.150,60

Spec.					T203M99	
-------	--	--	--	--	---------	--

SPARE PARTS

Type	Dimensions	Code	€
Reversible knife	24X12X1,5	● C028M02412AA	5,20
Clamping wedge	20X13X10	● ETASS13102015	10,80
Ogive clamp. sys.	15X13,5XM10sx	● WOG01	5,40
Screw	M10X22	● WV032	3,00
"T" allen key	Esag. 5	● ACHET05AAAAA	9,20

NOTE

■ Utensili non a magazzino, quantità minima d'ordine: **1 pezzo**.
Tools not ready in stock minimum order quantity: **1 piece**.

Il prezzo include coltelli e 1 chiave di regolazione.
The price included knives and 1 screwdriver.

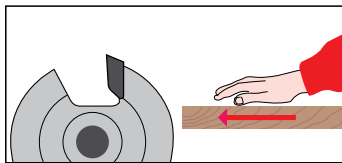
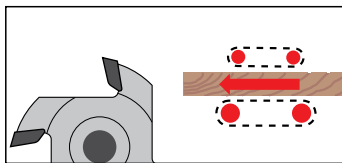
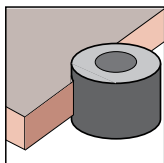
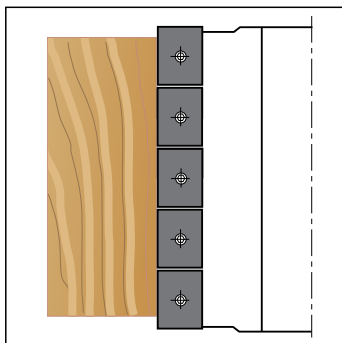
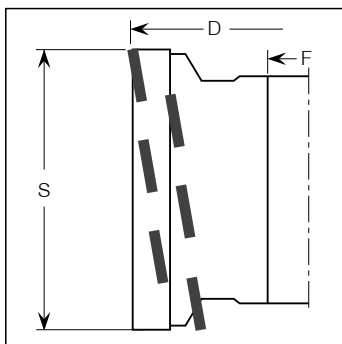

TAGLIO / SEZIONATURA
SAWING

DIAMANTE
DIAMOND

FRESATURA
CUTTING

PANTOGRAFATURA
ROUTING

FORATURA
BORING

MANDRINI / ATTACCHI
CHUCKS & CLAMPING SYSTEM

RICAMBI E LAVORAZIONI SUPP.
SPARE PARTS & ADD. WORKING

Teste hydro portacoltelli elicoidali assiali in lega leggera

Hydro Spiral-Hobel-Messerköpfe mit Achswinkel

Porte-outils en alliage à raboter à coupes biaisées avec hydro

Фрезерные головки гидро со сменными аксиальными ножами

T203H

HW Hydro axial spiral jointing cutterheads in light alloy

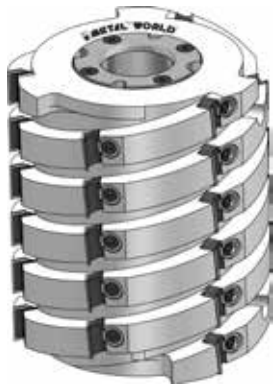

Costruite con corpo in lega leggera • Coltelli in HW a fissaggio meccanico • 6 divisioni • Il sistema hydro consente un perfetto accoppiamento tra l'utensile e l'albero macchina • Forma elicoidale ed ampi scarichi diminuiscono l'assorbimento di potenza, la rumorosità ed aumentano la durata degli utensili • La disposizione assiale dei denti permette una migliore finitura • L'elevata precisione della concentricità dei taglienti consente un maggior avanzamento e una migliore finitura • Indicate per medie asportazioni • Da montare su macchine scorniciatrici

Body in light alloy • HW turnover knives • 6 divisions • Hydro bush system for a perfect joint between the tool and the spindle of the machine • The large spiral execution reduces the electrical input and the noise and increases the tool life • The accuracy of concentricity of the cutting edges allows for greater feed speed and a better finish • Suitable for medium chip removal • Indicated to work curved panels • Can be used on moulding machines

3 CUTTING PRINCIPLES

● = Ready in stock ■ = Delivery time 20 working days ▲ = On request

D	S	Z	F	Code Type A	Code Type B	€
143	78	12	40	■ T203M143078A	■ T203M143078B	923,80
143	96	15	40	■ T203M143096A	■ T203M143096B	1.052,20
143	114	18	40	■ T203M143114A	■ T203M143114B	1.159,40
143	132	21	40	■ T203M143132A	■ T203M143132B	1.266,40
143	150	24	40	■ T203M143150A	■ T203M143150B	1.392,00
143	168	27	40	■ T203M143168A	■ T203M143168B	1.505,80
143	186	30	40	■ T203M143186A	■ T203M143186B	1.604,20
143	204	33	40	■ T203M143204A	■ T203M143204B	1.718,00
143	222	36	40	■ T203M143222A	■ T203M143222B	1.818,40
143	240	39	40	■ T203M143240A	■ T203M143240B	1.916,60
163	78	12	40	■ T203M163078A	■ T203M163078B	949,20
163	96	15	40	■ T203M163096A	■ T203M163096B	1.075,60
163	114	18	40	■ T203M163114A	■ T203M163114B	1.191,40
163	132	21	40	■ T203M163132A	■ T203M163132B	1.302,40
163	150	24	40	■ T203M163150A	■ T203M163150B	1.429,00
163	168	27	40	■ T203M163168A	■ T203M163168B	1.548,60
163	186	30	40	■ T203M163186A	■ T203M163186B	1.653,80
163	204	33	40	■ T203M163204A	■ T203M163204B	1.769,60
163	222	36	40	■ T203M163222A	■ T203M163222B	1.870,00
163	240	39	40	■ T203M163240A	■ T203M163240B	1.975,00

Spec.				T203M99	T203M99	
-------	--	--	--	---------	---------	--

SPARE PARTS

Type	Dimensions	Code	€
Reversible knife	24X12X1,5	● C028M02412AA	5,20
Clamping wedge	20X13X10	● ETASS13102015	10,80
Ogive clamp. sys.	15X13,5XM10sx	● WOG01	5,40
Screw	M10X22	● WV032	3,00
"T" allen key	Esag. 5	● ACHET05AAAAA	9,20
Hydro pump		● WAGREASEPUMP	940,40

NOTE

■ Utensili non a magazzino, quantità minima d'ordine: 1 pezzo.
Tools not ready in stock minimum order quantity: 1 piece.

Il prezzo include coltelli e 2 chiavi di regolazione.
The price included knives and 2 screwdrivers.

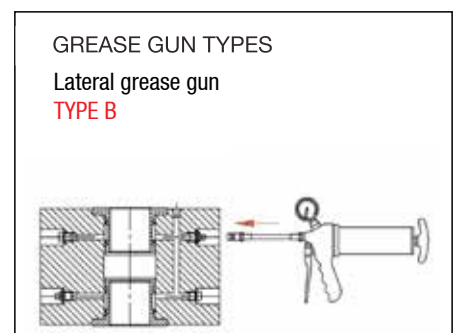
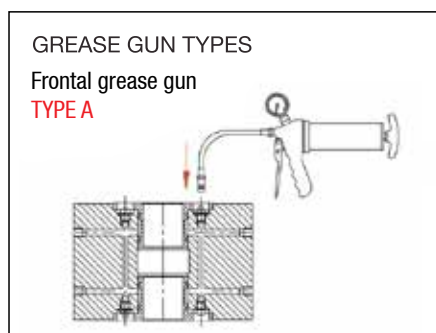

TAGLIO / SEZIONATURA
SAWING

DIAMANTE
DIAMOND

FRESATURA
CUTTING

PANTOGRAFATURA
ROUTING

FORATURA
BORING

MANDRINI / ATTACCHI
CHUCKS & CLAMPING SYSTEM

RICAMBI E LAVORAZIONI SUPP.
SPARE PARTS & ADD. WORKING

T204

HS / HW Planning cutterheads



Costruite con corpo in lega leggera o in acciaio bonificato • Dotate di 4 coltelli in HS (C011) a fissaggio meccanico • Possono essere dotate anche di coltelli in HW (C010) • Indicate per piccole e medie asportazioni • Buona finitura • Da montare su macchine sormontatrici

Body in light alloy or in hardened and tempered steel • 4 HS turnover knives (C011) • On request can be supplied with HW turnover knives (C010) • Suitable for small and medium chip removal • Good finish • Can be used on moulding machines

Z=4

● = Ready in stock ■ = Delivery time 20 working days △ = On request

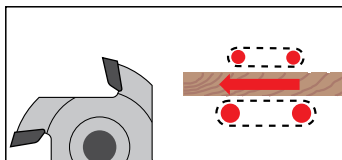
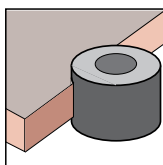
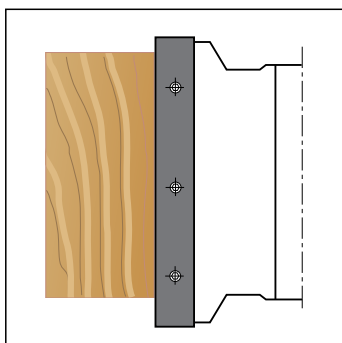
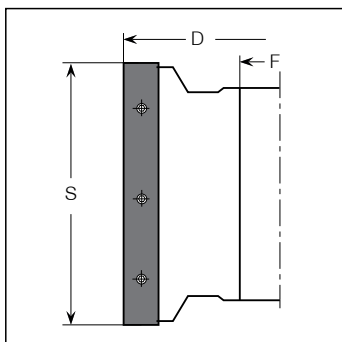

D	S	F	Steel code	Light alloy code	€
125	80	40	■ T204MAAAAAA	■ T204MAAAAABA	278,40
125	100	40	■ T204MABAAAAA	■ T204MABAAAABA	311,60
125	120	40	■ T204MACAAAAA	■ T204MACAAAABA	348,60
125	130	40	■ T204MADAAAAA	■ T204MADAAAABA	362,20
125	150	40	■ T204MAEAAAAA	■ T204MAEAAAABA	393,40
125	170	40	■ T204MAFAAAAA	■ T204MAFAAAAABA	424,40
125	180	40	■ T204MAGAAAAA	■ T204MAGAAAABA	436,20
125	210	40	■ T204MAHAAAAA	■ T204MAHAAAABA	473,20
125	230	40	■ T204MAJAAAAA	■ T204MAJAAAABA	498,40
125	240	40	■ T204MALAAAAA	■ T204MALAAAABA	514,00
140	120	40	■ T204MBCAAAAA	■ T204MBCAAAABA	385,60
140	130	40	■ T204MBDAAAAA	■ T204MBDAAAABA	401,20
140	150	40	■ T204MBEAAAAA	■ T204MBEAAAABA	430,40
140	180	40	■ T204MBGAAAAA	■ T204MBGAAAABA	481,00
140	210	40	■ T204MBHAAAAA	■ T204MBHAAAABA	523,80
140	230	40	■ T204MBJAAAAA	■ T204MBJAAAABA	548,00
140	240	40	■ T204MBLAAAAA	■ T204MBLAAAABA	560,80
Spec.			T204M99	T204M99	

SPARE PARTS

Type	Dimensions	Per S	Code	€
HS knife	80X30X3		● C011S0080AAA	7,00
HS knife	100X30X3		● C011S0100AAA	9,20
HS knife	120X30X3		● C011S0120AAA	7,60
HS knife	130X30X3		● C011S0130AAA	8,40
HS knife	150X30X3		● C011S0150AAA	9,60
HS knife	180X30X3		● C011S0180AAA	11,40
HS knife	210X30X3		● C011S0210AAA	16,60
HS knife	230X30X3		● C011S0230AAA	14,60
HS knife	240X30X3		● C011S0240AAA	19,00
Clamping wedge	78X19X15	80	● ETASS1915078	18,00
Clamping wedge	98X19X15	100	● ETASS1915098	19,80
Clamping wedge	118X19X15	120	● ETASS1915118	21,60
Clamping wedge	128X19X15	130	● ETASS1915128	22,50
Clamping wedge	148X19X15	150	● ETASS1915148	24,30
Clamping wedge	178X19X15	180	● ETASS1915178	27,00
Clamping wedge	208X19X15	210	● ETASS1915208	29,70
Clamping wedge	228X19X15	230	● ETASS1915228	31,50
Clamping wedge	238X19X15	240	● ETASS1915238	32,40
Screw	M10X20		● WV053	1,00
"T" allen key	Esag. 5		● ACHET05AAAAA	9,20

NOTE

■ Utensili non a magazzino, quantità minima d'ordine: **1 pezzo**.
Tools not ready in stock minimum order quantity: **1 piece**.

Il prezzo include coltelli e 1 chiave di regolazione.
The price included knives and 1 screwdriver.



Teste hydro portacoltelli per piallare

Hydro-Hobel-Messerköpfe

Porte-outils de rabotage avec hydro

Фрезерные головки гидро для строгальных станков

TAGLIO / SEZIONATURA
SAWING

DIAMANTE
DIAMOND

FRESATURA
CUTTING

PANTOGRAFATURA
ROUTING

FORATURA
BORING

MANDRINI / ATTACCHI
CHUCKS & CLAMPING SYSTEM

RICAMBI E LAVORAZIONI SUPP.
SPARE PARTS & ADD. WORKING

T204H

HS / HW Hydro planer cutterheads

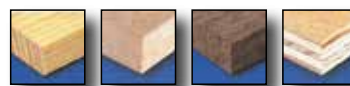

Costruite con corpo in lega leggera o in acciaio bonificato • Coltelli in HS (C011) a fissaggio meccanico • Possono essere dotate anche di coltelli in HW (C010) • Sistema hydro che consente un perfetto accoppiamento tra l'utensile e l'albero macchina • Indicate per piccole e medie asportazioni • L'elevata precisione della concentricità dei taglienti consente un maggior avanzamento e una migliore finitura • Da montare su macchine scorniciatrici

Body in light alloy or in hardened and tempered steel • 4 HS turnover knives (C011) • On request can be supplied with HW turnover knives (C010) • Hydro bush system for a perfect joint between the tool and the spindle of the machine • Suitable for small and medium chip removal • The accuracy of concentricity of the cutting edges allows for greater feed speed and a better finish • Can be used on moulding machines

Type A

● = Ready in stock ■ = Delivery time 20 working days ▲ = On request

D	S	Z	F	Steel code	Light alloy code	€
143	80	4	40	▲ T204MCAAACAA	▲ T204MCAAACBA	683,40
143	100	4	40	▲ T204MCBAABAA	▲ T204MCBAABBA	757,40
143	130	4	40	▲ T204MCDAABAA	▲ T204MCDAABBA	854,80
143	150	4	40	▲ T204MCEAABAA	▲ T204MCEAABBA	949,20
143	180	4	40	▲ T204MCGAABAA	▲ T204MCGAABBA	1.031,80
143	230	4	40	▲ T204MCJAABAA	▲ T204MCJAABBA	1.133,00
163	80	4	40	▲ T204MDAAABAA	▲ T204MDAAABBA	706,80
163	100	4	40	▲ T204MDBAABAA	▲ T204MDBAABBA	784,60
163	130	4	40	▲ T204MDDAABAA	▲ T204MDDAABBA	885,80
163	150	4	40	▲ T204MDEAABAA	▲ T204MDEAABBA	985,20
163	180	4	40	▲ T204MDECACBA	▲ T204MDGAABBA	1.068,80
163	230	4	40	▲ T204MDJAABAA	▲ T204MDJAABBA	1.176,00
163	80	6	40	▲ T204MDABABAA	▲ T204MDABABBA	885,80
163	100	6	40	▲ T204MDBBABAA	▲ T204MDBBABBA	979,20
163	130	6	40	▲ T204MDDBABAA	▲ T204MDDBABBA	1.109,80
163	150	6	40	▲ T204MDEBABAA	▲ T204MDEBABBA	1.231,40
163	180	6	40	▲ T204MDGACBA	▲ T204MDGBABBA	1.337,40
163	230	6	40	▲ T204MDJBABAA	▲ T204MDJBABBA	1.469,80
163	80	8	40	▲ T204MDACABAA	▲ T204MDACABBA	1.063,00
163	100	8	40	▲ T204MDBCABAA	▲ T204MDBCABBA	1.174,00
163	130	8	40	▲ T204MDDCABAA	▲ T204MDDCABBA	1.331,60
163	150	8	40	▲ T204MDECABAA	▲ T204MDECABBA	1.477,60
163	180	8	40	▲ T204MDGCABAA	▲ T204MDGCABBA	1.604,20
163	230	8	40	▲ T204MDJCABAA	▲ T204MDJCABBA	1.761,80
203	180	6	40	▲ T204MEGBABAA	▲ T204MEGBABBA	1.538,00
203	230	6	40	▲ T204MEJBABAA	▲ T204MEJBABBA	1.689,80
203	180	8	40	▲ T204MEGCABAA	▲ T204MEGCABBA	1.845,60
203	230	8	40	▲ T204MEJCABAA	▲ T204MEJCABBA	2.028,60
203	180	10	40	▲ T204MEGDABAA	▲ T204MEGDABBA	2.176,60
203	230	10	40	▲ T204MEJDABAA	▲ T204MEJDABBA	2.392,60

Spec.		T204M99	T204M99
-------	--	---------	---------

NOTE

■ Utensili non a magazzino, quantità minima d'ordine: 1 pezzo.
Tools not ready in stock minimum order quantity: 1 piece.

Il prezzo include coltelli e 2 chiavi di regolazione.
The price included knives and 2 screwdrivers.

GREASE GUN TYPES

Frontal grease gun
TYPE A

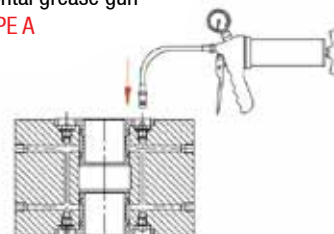

T204H HS / HW Hydro planer cutterheads



Costruite con corpo in lega leggera o in acciaio bonificato • Coltelli in HS (C011) a fissaggio meccanico • Possono essere dotate anche di coltelli in HW (C010) • Sistema hydro che consente un perfetto accoppiamento tra l'utensile e l'albero macchina • Indicate per piccole e medie asportazioni • L'elevata precisione della concentricità dei taglienti consente un maggior avanzamento e una migliore finitura • Da montare su macchine sornatrici

Body in light alloy or in hardened and tempered steel • 4 HS turnover knives (C011) • On request can be supplied with HW turnover knives (C010) • Hydro bush system for a perfect joint between the tool and the spindle of the machine • Suitable for small and medium chip removal • The accuracy of concentricity of the cutting edges allows for greater feed speed and a better finish • Can be used on moulding machines

Type B

● = Ready in stock ■ = Delivery time 20 working days △ = On request

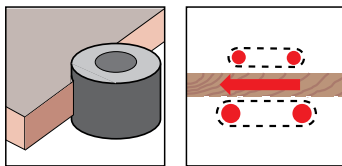
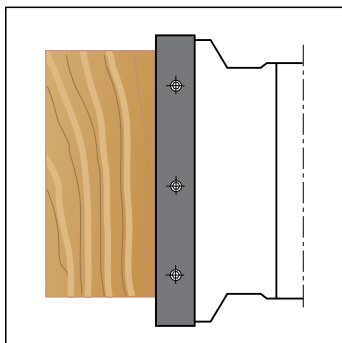
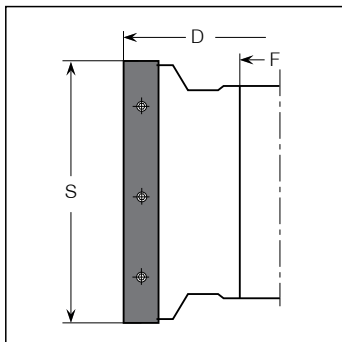

D	S	Z	F	Steel code	Light alloy code	€
143	80	4	40	△ T204MCAAACAA	△ T204MCAAACBA	683,40
143	100	4	40	△ T204MCBAACAA	△ T204MCBAACBA	757,40
143	130	4	40	△ T204MCDAACAA	△ T204MCDAACBA	854,80
143	150	4	40	△ T204MCEAACAA	△ T204MCEAACBA	949,20
143	180	4	40	△ T204MCGAACAA	△ T204MCGAACBA	1.031,80
143	230	4	40	△ T204MCJAACAA	△ T204MCJAACBA	1.133,00
163	80	4	40	△ T204MDAAACAA	△ T204MDAAACBA	706,80
163	100	4	40	△ T204MDBAACAA	△ T204MDBAACBA	784,60
163	130	4	40	△ T204MDDAACAA	△ T204MDDAACBA	885,80
163	150	4	40	△ T204MDEAACAA	△ T204MDEAACBA	985,20
163	180	4	40	△ T204MDGAACAA	△ T204MDGAACBA	1.068,80
163	230	4	40	△ T204MDJAACAA	△ T204MDJAACBA	1.176,00
163	80	6	40	△ T204MDABACAA	△ T204MDABACBA	885,80
163	100	6	40	△ T204MDBBACAA	△ T204MDBBACBA	979,20
163	130	6	40	△ T204MDDBACAA	△ T204MDDBACBA	1.109,80
163	150	6	40	△ T204MDEBACAA	△ T204MDEBACBA	1.231,40
163	180	6	40	△ T204MDGBACAA	△ T204MDGBACBA	1.337,40
163	230	6	40	△ T204MDJBACAA	△ T204MDJBACBA	1.469,80
163	80	8	40	△ T204MDACACAA	△ T204MDACACBA	1.063,00
163	100	8	40	△ T204MDBCACAA	△ T204MDBCACBA	1.174,00
163	130	8	40	△ T204MDDCACAA	△ T204MDDCACBA	1.331,60
163	150	8	40	△ T204MDECACAA	△ T204MDECACBA	1.477,60
163	180	8	40	△ T204MDGCACAA	△ T204MDGCACBA	1.604,20
163	230	8	40	△ T204MDJCACAA	△ T204MDJCACBA	1.761,80
203	180	6	40	△ T204MEGBACAA	△ T204MEGBACBA	1.538,00
203	230	6	40	△ T204MEJBACAA	△ T204MEJBACBA	1.689,80
203	180	8	40	△ T204MEGCACAA	△ T204MEGCACBA	1.845,60
203	230	8	40	△ T204MEJCACAA	△ T204MEJCACBA	2.028,60
203	180	10	40	△ T204MEGDACAA	△ T204MEGDACBA	2.176,60
203	230	10	40	△ T204MEJDACAA	△ T204MEJDACBA	2.392,60

Spec. _____

NOTE

■ Utensili non a magazzino, quantità minima d'ordine: 1 pezzo.
Tools not ready in stock minimum order quantity: 1 piece.

Il prezzo include coltelli e 2 chiavi di regolazione.
The price included knives and 2 screwdrivers.

GREASE GUN TYPES

Lateral grease gun
TYPE B

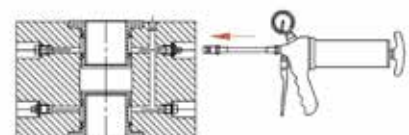

TAGLIO / SEZIONATURA
SAWING

DIAMANTE
DIAMOND

FRESATURA
CUTTING

PANTOGRAFATURA
ROUTING

FORATURA
BORING

MANDRINI / ATTACCHI
CHUCKS & CLAMPING SYSTEM

RICAMBI E LAVORAZIONI SUPP.
SPARE PARTS & ADD. WORKING

T204C

HS / HW Spare parts for T204-T204H cutterheads

TAGLIO / SEZIONATURA
SAWING

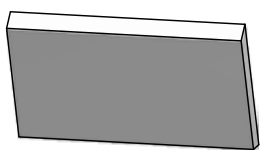

Coltelli in HS spessore 3 mm • Tasselli in acciaio bonificato

HS knives with 3 mm thickness • Clamping wedges in hardened and tempered steel

DIAMANTE
DIAMOND



FRESATURA
CUTTING



PANTOGRAFATURA
ROUTING

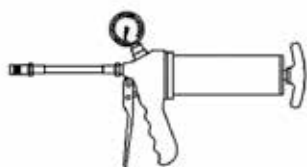

FORATURA
BORING

MANDRINI / ATTACCHI
CHUCKS & CLAMPING SYSTEM

RICAMBI E LAVORAZIONI SUPP.
SPARE PARTS & ADD. WORKING

SPARE PARTS

● = Ready in stock ■ = Delivery time 20 working days △ = On request

Type	Dimensions	Z	Per S	Code	€
HS knife	80X30X3			● C011S0080AAA	7,00
HS knife	100X30X3			● C011S0100AAA	9,200
HS knife	130X30X3			● C011S0130AAA	8,400
HS knife	150X30X3			● C011S0150AAA	9,60
HS knife	180X30X3			● C011S0180AAA	11,40
HS knife	230X30X3			● C011S0230AAA	14,60
HW knife	80X30X3			● C010M0080AAA	25,40
HW knife	100X30X3			● C010M0100AAA	30,00
HW knife	130X30X3			● C010M0130AAA	40,00
HW knife	150X30X3			● C010M0150AAA	45,60
HW knife	180X30X3			● C010M0180AAA	54,00
HW knife	230X30X3			● C010M0230AAA	69,60
Clamping wedge	78X19X15	4	80	● ETASS1915078	18,00
Clamping wedge	98X19X15	4	100	● ETASS1915098	19,80
Clamping wedge	128X19X15	4	130	● ETASS1915128	22,50
Clamping wedge	148X19X15	4	150	● ETASS1915148	24,30
Clamping wedge	178X19X15	4	180	● ETASS1915178	27,00
Clamping wedge	228X19X15	4	230	● ETASS1915228	31,50
Clamping wedge	78X24X11	6/8/10	80	● ETASS1124078	19,60
Clamping wedge	98X24X11	6/8/10	100	● ETASS1124098	21,60
Clamping wedge	128X24X11	6/8/10	130	● ETASS1124128	24,40
Clamping wedge	148X24X11	6/8/10	150	● ETASS1124148	26,40
Clamping wedge	178X24X11	6/8/10	180	● ETASS1124178	29,40
Clamping wedge	228X24X11	6/8/10	230	● ETASS1124228	34,20
Screw	M10X20			● WV053	1,00
"T" allen key	Esag. 5			● ACHET05AAAAA	9,20
Hydro pump				● WAGREASEPUMP	940,40

Teste per finitura
con coltello autoposizionante

Hobel-Messerköpfe
mit Flihkraftspannung

Porte-outils de rabotage

Фрезерные головки
QUICK SYSTEM для
строгания

T207

QUICK SYSTEM

HS Finishing cutterheads with self positioning knives



Costruite con corpo in lega leggera o in acciaio bonificato • Dotate di n. 4 coltelli HS Centrolock **autoposizionanti** a fissaggio meccanico • Possono essere dotate anche di coltelli HW Centrolock • Buona finitura • Da montare su macchine scorniciatrici

Body in light alloy or in hardened and tempered steel • 4 HS turnover knives Centrolock self positioning • On request can be supplied with HW turnover knives Centrolock self positioning • Suitable for small and medium chip removal • Good finish • Can be used on moulding machines

Z=4

● = Ready in stock ■ = Delivery time 20 working days △ = On request

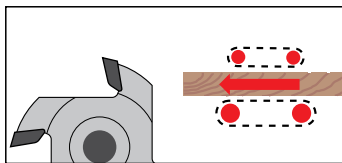
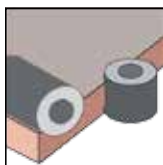
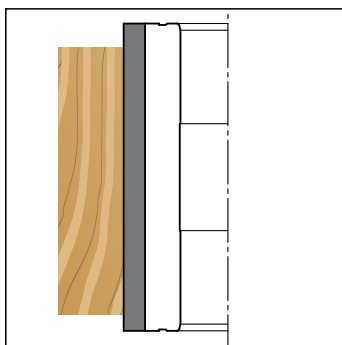
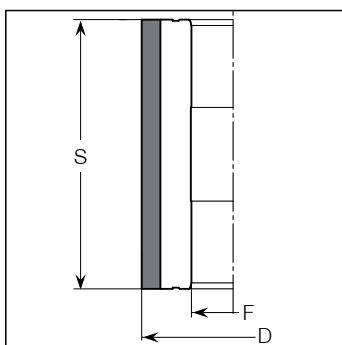

D	S	F	Z	Steel code	Light alloy code	€
125	100	40	4	■ T207MA125100	■ T207ML125100	373,80
125	130	40	4	■ T207MA125130	● T207ML125130	436,20
125	150	40	4	■ T207MA125150	■ T207ML125150	471,20
125	180	40	4	■ T207MA125180	■ T207ML125180	523,80
125	210	40	4	■ T207MA125210	■ T207ML125210	568,60
125	230	40	4	■ T207MA125230	● T207ML125230	599,60
125	240	40	4	■ T207MA125240	■ T207ML125240	617,20
140	130	40	4	■ T207MA140130	● T207ML140130	481,00
140	150	40	4	■ T207MA140150	■ T207ML140150	516,00
140	180	40	4	■ T207MA140180	■ T207ML140180	576,40
140	210	40	4	■ T207MA140210	■ T207ML140210	549,00
140	230	40	4	■ T207MA140230	■ T207ML140230	658,00
140	240	40	4	■ T207MA140240	■ T207ML140240	673,60

Spec. T207M99 T207M99

SPARE PARTS

Type	Dimensions	Code	€
HS knife	100X16X3	● C003S100AAAA	14,20
HS knife	130X16X3	● C003S130AAAA	14,40
HS knife	150X16X3	● C003S150AAAA	16,60
HS knife	180X16X3	● C003S180AAAA	20,80
HS knife	210X16X3	● C003S210AAAA	24,40
HS knife	230X16X3	● C003S230AAAA	25,40
HS knife	240X16X3	● C003S240AAAA	26,60
HW knife	100X16X3	● C004M100AAAA	45,00
HW knife	130X16X3	● C004M130AAAA	56,00
HW knife	150X16X3	● C004M150AAAA	61,80
HW knife	180X16X3	● C004M180AAAA	66,00
HW knife	210X16X3	● C004M210AAAA	80,40
HW knife	230X16X3	● C004M230AAAA	86,60
HW knife	240X16X3	● C004M240AAAA	97,00
Clamping wedge	98X18,2X14,7	● ETASS1518098	19,80
Clamping wedge	128X18,2X14,7	● ETASS1518128	21,60
Clamping wedge	148X18,2X14,7	● ETASS1518148	22,50
Clamping wedge	178X18,2X14,7	● ETASS1518178	24,30
Clamping wedge	208X18,2X14,7	● ETASS1518208	27,00
Clamping wedge	228X18,2X14,7	● ETASS1518228	29,70
Clamping wedge	238X18,2X14,7	● ETASS1518238	31,50
Screw	M6X20	● WV069	1,00
"T" allen key	Esag. 3	● ACHET03AAAAA	10,30

NOTE

■ Utensili non a magazzino, quantità minima d'ordine: **1 pezzo**.
Tools not ready in stock minimum order quantity: **1 piece**.

Il prezzo include coltelli e 1 chiave di regolazione.
The price included knives and 1 screwdriver.

Teste Hydro per finiture con coltello autoposizionante

Hydro Hobel-Messerköpfe mit Fliehkraftspannung

Porte-outils de rabotage avec hydro

Фрезерные головки гидро QUICK SYSTEM для строгания

T207H

QUICK SYSTEM

HS / HW HYDRO Finishing cutterheads with self positioning knives

TAGLIO / SEZIONATURA
SAWING

DIAMANTE
DIAMOND

FRESATURA
CUTTING

PANTOGRAFATURA
ROUTING

FORATURA
BORING

MANDRINI / ATTACCHI
CHUCKS & CLAMPING SYSTEM

RICAMBI E LAVORAZIONI SUPP.
SPARE PARTS & ADD. WORKING

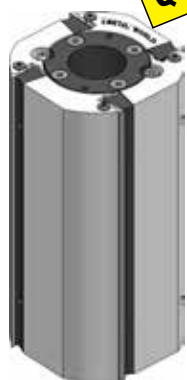

Costruite con corpo in lega leggera o in acciaio bonificato • Completi di attacco Hydro • Dotate di n. 4 coltelli HS Centrolock **autoposizionanti** a fissaggio meccanico • Possono essere dotate anche di coltelli HW Centrolock • Buona finitura • Da montare su macchine scorniciatrici

Body in light alloy or in hardened and tempered steel • Complete with Hydro sleeve • 4 HS turnover knives Centrolock self positioning • On request can be supplied with HW turnover knives Centrolock self positioning • Suitable for small and medium chip removal • Good finish • Can be used on moulding machines

Type A
Z=4/6/8/10

● = Ready in stock ■ = Delivery time 20 working days △ = On request

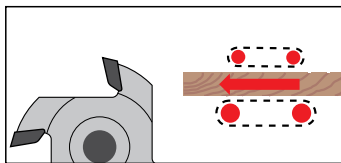
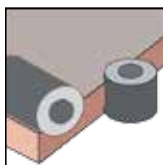
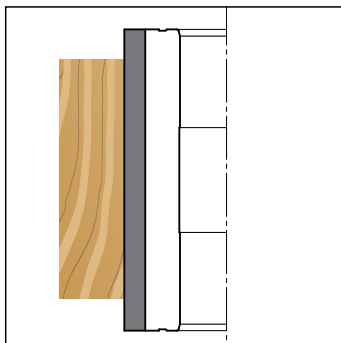
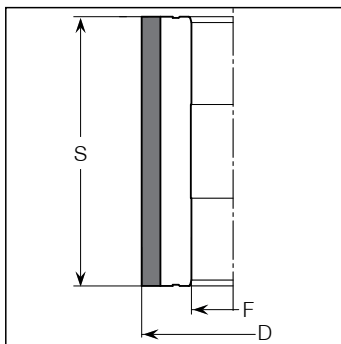

D	S	Z	F	Steel code	Light alloy code	€
143	100	4	40	△ T207M14310AA	△ T207M14310AH	673,20
143	130	4	40	△ T207M14313AA	△ T207M14313AH	759,80
143	150	4	40	△ T207M14315AA	△ T207M14315AH	843,60
143	180	4	40	△ T207M14318AA	△ T207M14318AH	917,20
143	210	4	40	△ T207M14321AA	△ T207M14321AH	1.171,20
143	230	4	40	△ T207M14323AA	△ T207M14323AH	1.425,00
143	240	4	40	△ T207M14324AA	△ T207M14324AH	1.567,00
163	130	4	40	△ T207M16313AB	△ T207M16313AI	787,40
163	150	4	40	△ T207M16315AB	△ T207M16315AI	875,60
163	180	4	40	△ T207M16318AB	△ T207M16318AI	950,00
163	210	4	40	△ T207M16321AB	△ T207M16321AI	997,60
163	230	4	40	△ T207M16323AB	△ T207M16323AI	1.045,20
163	240	4	40	△ T207M16324AB	△ T207M16324AI	1.150,00
163	130	6	40	△ T207M16313AC	△ T207M16313AL	986,40
163	150	6	40	△ T207M16315AC	△ T207M16315AL	1.094,60
163	180	6	40	△ T207M16318AC	△ T207M16318AL	1.188,80
163	210	6	40	△ T207M16321AC	△ T207M16321AL	1.247,80
163	230	6	40	△ T207M16323AC	△ T207M16323AL	1.306,80
163	240	6	40	△ T207M16324AC	△ T207M16324AL	1.436,00
163	130	8	40	△ T207M16313AD	△ T207M16313AM	1.183,60
163	150	8	40	△ T207M16315AD	△ T207M16315AM	1.313,40
163	180	8	40	△ T207M16318AD	△ T207M16318AM	1.426,00
163	210	8	40	△ T207M16321AD	△ T207M16321AM	1.496,00
163	230	8	40	△ T207M16323AD	△ T207M16323AM	1.566,20
163	240	8	40	△ T207M16324AD	△ T207M16324AM	1.722,00
203	180	6	40	△ T207M20318AE	△ T207M20318AN	1.538,00
203	230	6	40	△ T207M20323AE	△ T207M20323AN	1.689,80
203	240	6	40	△ T207M20324AE	△ T207M20324AN	1.860,00
203	180	8	40	△ T207M20318AF	△ T207M20318AO	1.845,60
203	230	8	40	△ T207M20323AF	△ T207M20323AO	2.028,60
203	240	8	40	△ T207M20324AF	△ T207M20324AO	2.230,00
203	180	10	40	△ T207M20318AG	△ T207M20318AP	2.176,00
203	230	10	40	△ T207M20323AG	△ T207M20323AP	2.392,60
203	240	10	40	△ T207M20324AG	△ T207M20324AP	2.630,00

Spec.				T207M99	T207M99
-------	--	--	--	---------	---------

NOTE

■ Utensili non a magazzino, quantità minima d'ordine: **1 pezzo.**
Tools not ready in stock minimum order quantity: **1 piece.**

Il prezzo include coltelli e 1 chiave di regolazione.
The price included knives and 1 screwdriver.

GREASE GUN TYPES

Frontal grease gun
TYPE A

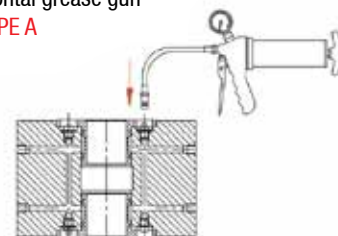

Teste Hydro per finiture
con coltello autoposizionante

Hydro Hobel-Messerköpfe
mit Fliehkraftspannung

Porte-outils de rabotage
avec hydro

Фрезерные головки
гидро QUICK SYSTEM
для строгания



T207H

QUICK SYSTEM

HS / HW HYDRO Finishing cutterheads with self positioning knives



Costruite con corpo in lega leggera o in acciaio bonificato • Completi di attacco Hydro • Dotate di n. 4 coltelli HS Centrolock **autoposizionanti** a fissaggio meccanico • Possono essere dotate anche di coltelli HW Centrolock • Buona finitura • Da montare su macchine scorniciatrici

Body in light alloy or in hardened and tempered steel • Complete with Hydro sleeve • 4 HS turnover knives Centrolock self positioning • On request can be supplied with HW turnover knives Centrolock self positioning • Suitable for small and medium chip removal • Good finish • Can be used on moulding machines

Type B

Z=4/6/8/10

● = Ready in stock ■ = Delivery time 20 working days ▲ = On request

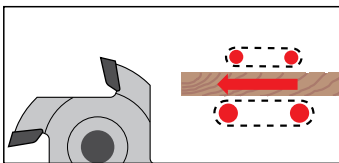
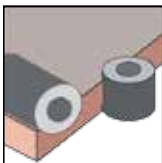
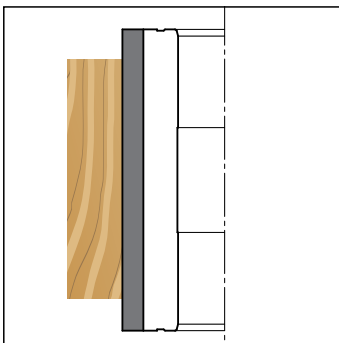
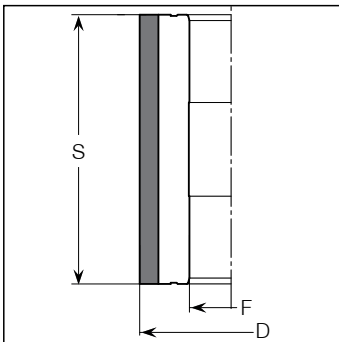

D	S	Z	F	Steel code	Light alloy code	€
143	100	4	40	▲ T207M14310BA	▲ T207M14310BH	673,20
143	130	4	40	▲ T207M14313BA	▲ T207M14313BH	759,80
143	150	4	40	▲ T207M14315BA	▲ T207M14315BH	843,60
143	180	4	40	▲ T207M14318BA	▲ T207M14318BH	917,20
143	210	4	40	▲ T207M14321BA	▲ T207M14321BH	1.171,20
143	230	4	40	▲ T207M14323BA	▲ T207M14323BH	1.425,00
143	240	4	40	▲ T207M14324BA	▲ T207M14324BH	1.567,00
163	130	4	40	▲ T207M16313BB	▲ T207M16313BI	787,40
163	150	4	40	▲ T207M16315BB	▲ T207M16315BI	875,60
163	180	4	40	▲ T207M16318BB	▲ T207M16318BI	950,00
163	210	4	40	▲ T207M16321BB	▲ T207M16321BI	997,60
163	230	4	40	▲ T207M16323BB	▲ T207M16323BI	1.045,20
163	240	4	40	▲ T207M16324BB	▲ T207M16324BI	1.150,00
163	130	6	40	▲ T207M16313BC	▲ T207M16313BL	986,40
163	150	6	40	▲ T207M16315BC	▲ T207M16315BL	1.094,60
163	180	6	40	▲ T207M16318BC	▲ T207M16318BL	1.188,80
163	210	6	40	▲ T207M16321BC	▲ T207M16321BL	1.247,80
163	230	6	40	▲ T207M16323BC	▲ T207M16323BL	1.306,80
163	240	6	40	▲ T207M16324BC	▲ T207M16324BL	1.436,00
163	130	8	40	▲ T207M16313BD	▲ T207M16313BM	1.183,60
163	150	8	40	▲ T207M16315BD	▲ T207M16315BM	1.313,40
163	180	8	40	▲ T207M16318BD	▲ T207M16318BM	1.426,00
163	210	8	40	▲ T207M16321BD	▲ T207M16321BM	1.496,00
163	230	8	40	▲ T207M16323BD	▲ T207M16323BM	1.566,20
163	240	8	40	▲ T207M16324BD	▲ T207M16324BM	1.722,00
203	180	6	40	▲ T207M20318BE	▲ T207M20318BN	1.538,00
203	230	6	40	▲ T207M20323BE	▲ T207M20323BN	1.689,80
203	240	6	40	▲ T207M20324BE	▲ T207M20324BN	1.860,00
203	180	8	40	▲ T207M20318BF	▲ T207M20318BO	1.845,60
203	230	8	40	▲ T207M20323BF	▲ T207M20323BO	2.028,60
203	240	8	40	▲ T207M20324BF	▲ T207M20324BO	2.230,00
203	180	10	40	▲ T207M20318BG	▲ T207M20318BP	2.176,60
203	230	10	40	▲ T207M20323BG	▲ T207M20323BP	2.392,60
203	240	10	40	▲ T207M20324BG	▲ T207M20324BP	2.630,00

Spec.				T207M99	T207M99
-------	--	--	--	---------	---------

NOTE

■ Utensili non a magazzino, quantità minima d'ordine: **1 pezzo.**
Tools not ready in stock minimum order quantity: **1 piece.**

Il prezzo include coltelli e 1 chiave di regolazione.
The price included knives and 1 screwdriver.

GREASE GUN TYPES

Lateral grease gun
TYPE B

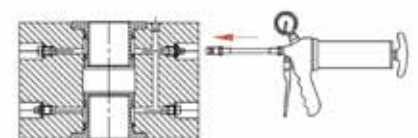

TAGLIO / SEZIONATURA
SAWING

DIAMANTE
DIAMOND

FRESATURA
CUTTING

PANTOGRAFATURA
ROUTING

FORATURA
BORING

MANDRINI / ATTACCHI
CHUCKS & CLAMPING SYSTEM

RICAMBI E LAVORAZIONI SUPP.
SPARE PARTS & ADD. WORKING

Teste per macchine Weing per finitura con coltello autoposizionante

Hobel-Messerköpfe mit Fliehkraftspannung

Porte-outils de rabotage pour Weing

Фрезерные головки QUICK SYSTEM для станков Weing

T207W

QUICK SYSTEM

HS / HW Finishing cutterheads with self positioning knives

TAGLIO / SEZIONATURA
SAWING

DIAMANTE
DIAMOND

FRESATURA
CUTTING

PANTOGRAFATURA
ROUTING

FORATURA
BORING

MANDRINI / ATTACCHI
CHUCKS & CLAMPING SYSTEM

RICAMBI E LAVORAZIONI SUPP.
SPARE PARTS & ADD. WORKING



Costruite con corpo in acciaio bonificato • Dotate di coltelli HS o HW Centrolock autoposizionanti a fissaggio meccanico
• Buona finitura • Attacco Power Lock per macchine Weing e SCM

Body in hardened and tempered steel • Knives Centrolock self positioning • On request can be supplied with HW turnover knives Centrolock self positioning • Good finish • Can be used on Weing and SCM machines

Z=2/4

● = Ready in stock ■ = Delivery time 20 working days △ = On request

D	S	Z	Steel code	Light alloy code	€
125	100	2	△ T207M12510CA	△ T207M12510DA	638,00
125	130	2	△ T207M12513CA	△ T207M12513DA	722,60
125	150	2	△ T207M12515CA	△ T207M12515DA	801,80
125	180	2	△ T207M12518CA	△ T207M12518DA	959,80
125	210	2	△ T207M12521CA	△ T207M12521DA	1.042,60
125	230	2	△ T207M12523CA	△ T207M12523DA	1.125,20
125	100	4	△ T207M12510CB	△ T207M12510DB	681,40
125	130	4	△ T207M12513CB	△ T207M12513DB	767,40
125	150	4	△ T207M12515CB	△ T207M12515DB	853,40
125	180	4	△ T207M12518CB	△ T207M12518DB	1.023,80
125	210	4	△ T207M12521CB	△ T207M12521DB	1.112,00
125	230	4	△ T207M12523CB	△ T207M12523DB	1.200,20

Spec.	T207M99	T207M99
-------	---------	---------

NOTE

■ Utensili non a magazzino, quantità minima d'ordine: **1 pezzo.**
Tools not ready in stock minimum order quantity: **1 piece.**

Il prezzo include coltelli e 1 chiave di regolazione.
The price included knives and 1 screwdriver.

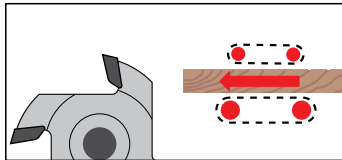
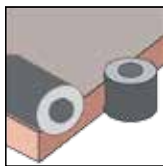
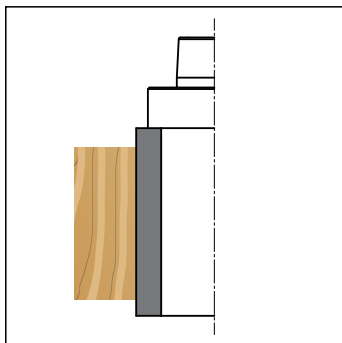
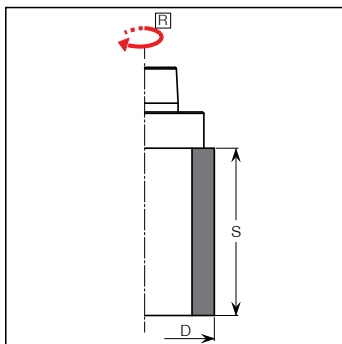



T207C

HS / HW Spare parts for cutterheads T207-T207H-T207W



Coltelli in HS spessore 3 mm • Tasselli in acciaio bonificato • Coltelli in HW spessore 3 mm • Tasselli in acciaio bonificato

HS knives with 3 mm thickness • Clamping wedges in hardened and tempered steel • HW knives with 3 mm thickness • Clamping wedges in hardened and tempered steel

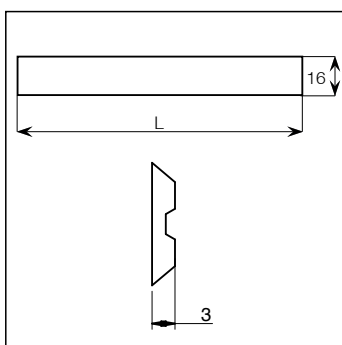

● = Ready in stock ■ = Delivery time 20 working days △ = On request

Type	Dimensions	Code	€
HS knife	100X16X3	● C003S100AAAA	14,20
HS knife	130X16X3	● C003S130AAAA	14,40
HS knife	150X16X3	● C003S150AAAA	16,60
HS knife	180X16X3	● C003S180AAAA	20,80
HS knife	210X16X3	● C003S210AAAA	24,40
HS knife	230X16X3	● C003S230AAAA	25,40
HS knife	240X16X3	● C003S240AAAA	26,60
HW knife	100X16X3	● C004M100AAAA	45,00
HW knife	130X16X3	● C004M130AAAA	56,00
HW knife	150X16X3	● C004M150AAAA	61,80
HW knife	180X16X3	● C004M180AAAA	66,00
HW knife	210X16X3	● C004M210AAAA	80,40
HW knife	230X16X3	● C004M230AAAA	86,60
HW knife	240X16X3	● C004M240AAAA	97,00
Clamping wedge	98X18,2X14,7	● ETASS1518098	19,80
Clamping wedge	128X18,2X14,7	● ETASS1518128	21,60
Clamping wedge	148X18,2X14,7	● ETASS1518148	22,50
Clamping wedge	178X18,2X14,7	● ETASS1518178	24,30
Clamping wedge	208X18,2X14,7	● ETASS1518208	27,00
Clamping wedge	228X18,2X14,7	● ETASS1518228	29,70
Clamping wedge	238X18,2X14,7	● ETASS1518238	31,50
Screw	M6X20	● WVTPSM06X20	1,00
"T" allen key	Esag. 3	● ACHET03AAAAA	7,60
Hydro pump		● WAGREASEPUMP	940,40

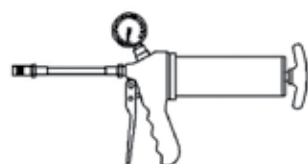

TAGLIO / SEZIONATURA
SAWING

DIAMANTE
DIAMOND

FRESATURA
CUTTING

PANTOGRAFATURA
ROUTING

FORATURA
BORING

MANDRINI / ATTACCHI
CHUCKS & CLAMPING SYSTEM

RICAMBI E LAVORAZIONI SUPP.
SPARE PARTS & ADD. WORKING

Teste pialla con inserti raggiatori e spigolatori registrabili

Messerköpfe mit standard Kanten-Abrund/Fase Wendemesser

Porte-outils de rabotage avec couteaux biseautés arrêtes

Фрезерная головка для строгания с регулируемыми ножами для фасок

T207R

QUICK SYSTEM

HS Planer cutterheads with adjustable inserts



Testa pialla con inserti raggiatori registrabili (raggi da 1,5 a 5) • Costruite con corpo in lega leggera o in acciaio bonificato • Possibilità di eseguire profilo smussato • Dotate di n. 4 coltelli HS Centrolock autopositionanti a fissaggio meccanico • Possono essere dotate anche di coltelli HW Centrolock • Buona finitura • Da montare su macchine scormiatrici

Planer cutterhead with adjustable inserts (radius from 1,5 to 5) • Body in light alloy or in hardened and tempered steel • Possibility to do bevelling profiles • 4 HS turnover knives Centrolock self positioning • On request can be supplied with HW turnover knives Centrolock self positioning • Suitable for small and medium chip removal • Good finish • Can be used on moulding machines

Z=4

● = Ready in stock ■ = Delivery time 20 working days △ = On request

D	S	I	F	Steel code	Light alloy code	€
125	100	2+2	40	△ T207SR12510E	△ T207SR12510F	748,00
125	130	2+2	40	△ T207SR12513E	△ T207SR12513F	832,00
125	150	2+2	40	△ T207SR12515E	△ T207SR12515F	910,20
125	180	2+2	40	△ T207SR12518E	△ T207SR12518F	1.006,20
125	210	2+2	40	△ T207SR12521E	△ T207SR12521F	1.072,60
125	230	2+2	40	△ T207SR12523E	△ T207SR12523F	1.131,80
140	130	2+2	40	△ T207SR14013E	△ T207SR14013F	876,80
140	150	2+2	40	△ T207SR14015E	△ T207SR14015F	955,00
140	180	2+2	40	△ T207SR14018E	△ T207SR14018F	1.058,60
140	210	2+2	40	△ T207SR14021E	△ T207SR14021F	1.053,00
140	230	2+2	40	△ T207SR14023E	△ T207SR14023F	1.190,20

Spec.

T207M99

T207M99

NOTE

■ Utensili non a magazzino, quantità minima d'ordine: **1 pezzo**.
Tools not ready in stock minimum order quantity: **1 piece**.

Il prezzo include coltelli e 2 chiavi di regolazione.
The price included knives and 2 screwdrivers.

TAGLIO / SEZIONATURA
SAWING

DIAMANTE
DIAMOND

FRESATURA
CUTTING

PANTOGRAFATURA
ROUTING

FORATURA
BORING

MANDRINI / ATTACCHI
CHUCKS & CLAMPING SYSTEM

RICAMBI E LAVORAZIONI SUPP.
SPARE PARTS & ADD. WORKING



TAGLIO / SEZIONATURA
SAWING

DIAMANTE
DIAMOND

FRESATURA
CUTTING

PANTOGRAFATURA
ROUTING

FORATURA
BORING

MANDRINI / ATTACCHI
CHUCKS & CLAMPING SYSTEM

RICAMBI E LAVORAZIONI SUPP.
SPARE PARTS & ADD. WORKING

T207RC

HS / HW Spare parts for cutterheads T207R



Coltelli in HS spessore 3 mm • Coltelli in HW spessore 3 mm • Inserti reversibili raggiati e inclinati in HWM • Tasselli in acciaio bonificato

HS knives with 3 mm thickness • HW knives with 3 mm thickness • HWM radius and bevel inserts • Clamping wedges in hardened and tempered steel • Clamping wedges in hardened and tempered steel

● = Ready in stock ■ = Delivery time 20 working days △ = On request

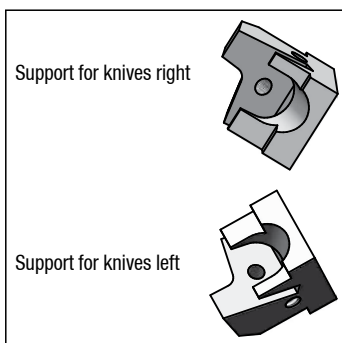
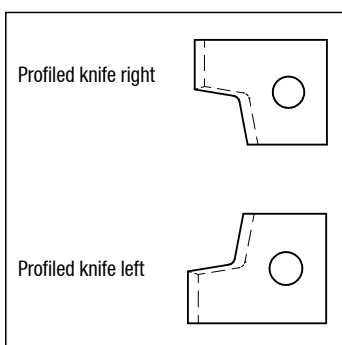
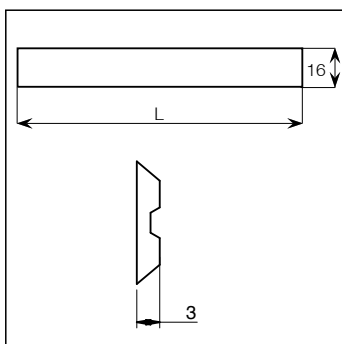
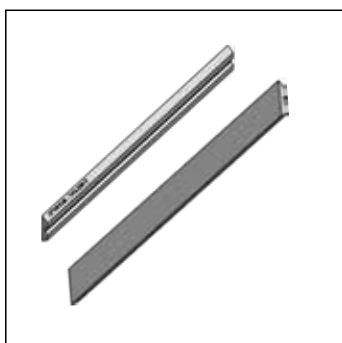

Type	Dimensions	Code	€
HS knife	100X16X3	● C003S100AAAA	14,20
HS knife	130X16X3	● C003S130AAAA	14,40
HS knife	150X16X3	● C003S150AAAA	16,60
HS knife	180X16X3	● C003S180AAAA	20,80
HS knife	210X16X3	● C003S210AAAA	24,40
HS knife	230X16X3	● C003S230AAAA	25,40
HS knife	240X16X3	● C003S240AAAA	26,60
HW knife	100X16X3	● C004M100AAAA	45,00
HW knife	130X16X3	● C004M130AAAA	56,00
HW knife	150X16X3	● C004M150AAAA	61,80
HW knife	180X16X3	● C004M180AAAA	66,00
HW knife	210X16X3	● C004M210AAAA	80,40
HW knife	230X16X3	● C004M230AAAA	86,60
HW knife	240X16X3	● C004M240AAAA	97,00
Clamping wedge	98X18,2X14,7	● ETASS1518098	19,80
Clamping wedge	128X18,2X14,7	● ETASS1518128	21,60
Clamping wedge	148X18,2X14,7	● ETASS1518148	22,50
Clamping wedge	178X18,2X14,7	● ETASS1518178	24,30
Clamping wedge	208X18,2X14,7	● ETASS1518208	27,00
Clamping wedge	228X18,2X14,7	● ETASS1518228	29,70
Clamping wedge	228X18,2X14,7	● ETASS1518238	31,50
Screw	M6X20	● WTPSM06X20	0,40
"T" allen key	Esag. 3	● ACHET03AAAA	7,40
Profiled knife RH – R=1	15X20X2	● CS00M01510RH	25,00
Profiled knife RH – R=1,5	15X20X2	● CS00M01515RH	25,00
Profiled knife RH – R=2	15X20X2	● CS00M01520RH	25,00
Profiled knife RH – R=3	15X20X2	● CS00M01530RH	25,00
Profiled knife RH – R=4	15X20X2	● CS00M01540RH	25,00
Profiled knife RH – R=5	15X20X2	● CS00M01550RH	25,00
Profiled knife RH – 45°	15X20X2	● CS00M0SM4512H	25,00
Profiled knife LH – R=1	15X20X2	● CS00M01510LH	25,00
Profiled knife LH – R=1,5	15X20X2	● CS00M01515LH	25,00
Profiled knife LH – R=2	15X20X2	● CS00M01520LH	25,00
Profiled knife LH – R=3	15X20X2	● CS00M01530LH	25,00
Profiled knife LH – R=4	15X20X2	● CS00M01540LH	25,00
Profiled knife LH – R=5	15X20X2	● CS00M01550LH	25,00
Profiled knife LH – 45°	15X20X2	● CS00M0SM45LH	25,00
Support for knives holder RH	17X21X22	● SUPPSM1721RH	43,20
Support for knives holder LH	17X21X22	● SUPPSM1721LH	43,20
Screw for profiled knives		● WV005	3,00
Clamping screw		● WV029	1,00
Positioning screw for profiled knives		● WV005	3,00

Teste portacoltelli per smussi a 45°

Fase-Messerköpfe

Porte outils à chanfreiner à plaquettes réversibles

Фрезы со сменным ножом на 45°

T210

HW Chamfering 45° cutterheads



Testa per smussi a 45° con coltelli standard • 4 coltelli in HW • Buona finitura • Indicate per piccole e medie asportazioni

Chamfering 45° cutterhead • 4 standard knives in HW • Good finish in different application • Suitable for small and medium chip removal

TAGLIO / SEZIONATURA
SAWING

DIAMANTE
DIAMOND

FRESATURA
CUTTING

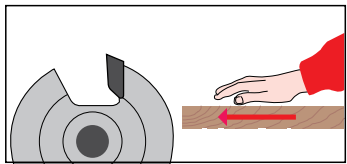
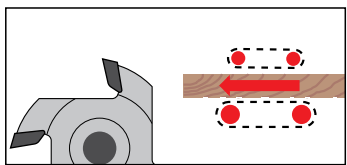
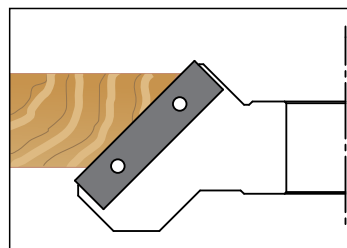
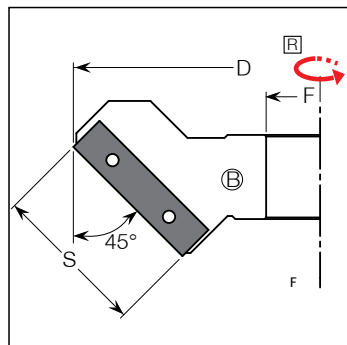
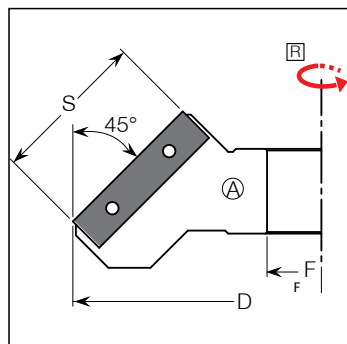

PANTOGRAFATURA
ROUTING

FORATURA
BORING

MANDRINI / ATTACCHI
CHUCKS & CLAMPING SYSTEM

RICAMBI E LAVORAZIONI SUPP.
SPARE PARTS & ADD. WORKING

Z=4

● = Ready in stock ■ = Delivery time 20 working days △ = On request

D	S	F	Mod.	Code	€
160	30	30	A	■ T210M16030AA	292,20
180	50	30	A	■ T210M16050AA	313,80
160	30	30	B	■ T210M16030BA	292,20
180	50	30	B	■ T210M16050BA	313,80
Spec.				T210M99	

SPARE PARTS

Type	Dimensions	Code	€
Reversible knife	30X12X1,5	● C020M30012AB	3,40
Reversible knife	50X12X1,5	● C020M50012AB	4,60
Clamping wedge	13X10X26	● ETASS131026P2	11,70
Clamping wedge	13X10X46	● ETASS131046P	14,40
Screw	M10X22	● WV032	3,0
Ogive clamp. system	15X13,5XM10SX	● WOG01	5,40
"T" allen key	Esag. 5	● ACHET05AAAAA	9,20

NOTE

■ Utensili non a magazzino, quantità minima d'ordine: **1 pezzo.**
Tools not ready in stock minimum order quantity: **1 piece.**

Il prezzo include coltelli e 1 chiave di regolazione.
The price included knives and 1 screwdriver.

T216

HW Set of tools for inside door's profiles

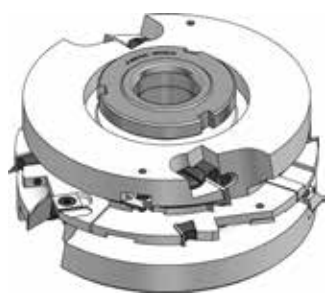

Gruppi per porte e portoncini sagomati • Costruite con corpo in acciaio bonificato • Coltelli in HW a fissaggio meccanico • Le teste in quanto componibili permettono la realizzazione di 6 diversi profili di svariate misure • Lavorano su macchine toupie, scorniciatrici e squadratrici

Profiled cutters set for inside door production • Body in hardened and tempered steel • HW turnover knives • The cutterhead as modular allow the creation of 6 different profiles of various sizes • To mount on toupie, moulding machines and tenoning machines

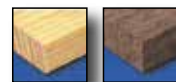

TAGLIO / SEZIONATURA
SAWING

DIAMANTE
DIAMOND

FRESATURA
CUTTING

PANTOGRAFATURA
ROUTING

FORATURA
BORING

MANDRINI / ATTACCHI
CHUCKS & CLAMPING SYSTEM

RICAMBI E LAVORAZIONI SUPP.
SPARE PARTS & ADD. WORKING

Z=2

● = Ready in stock ■ = Delivery time 20 working days △ = On request

Nr	D	S	Z	V	S1	F	Code	€
1	160	25	2		2	50	△ T216M1602501	278,40
2	166	8	2	2	2	50	△ T216M1660802	441,00
3	166	8	2	2	2	50	△ T216M1660803	441,00
4	160	25	2		2	50	△ T216M1602504	253,20
5	160	30	2	2	4	50	△ T216M1603005	328,20
6	50	100				30	△ B0300100AAAR	175,40

SPARE PARTS

Type	Dimensions	Nr	Prof.	R	Code	€
Profile knife	25X30X2	1	A		△ C216M2530P1A	25,00
Profile knife	25X30X2	1	B		△ C216M2530P1B	25,00
Profile knife	25X30X2	1	C		△ C216M2530P1C	25,00
Profile knife	25X30X2	1	D		△ C216M2530P1D	25,00
Profile knife	25X30X2	1	E		△ C216M2530P1E	25,00
Profile knife	25X30X2	1	F		△ C216M2530P1F	25,00
Reversible knife	7,5X12X1,5	2,3			● C020M07512AA	2,00
Profile knife	25X30X2	4	A		△ C216M2530P4A	25,00
Profile knife	25X30X2	4	B		△ C216M2530P4B	25,00
Profile knife	25X30X2	4	C		△ C216M2530P4C	25,00
Profile knife	25X30X2	4	D		△ C216M2530P4D	25,00
Profile knife	25X30X2	4	E		△ C216M2530P4E	25,00
Profile knife	25X30X2	4	F		△ C216M2530P4F	25,00
Reversible knife	30X12X1,5	5			● C020M30012AB	3,40
Radius insert	22X16X5	1,4		3	● C044M220R30A	20,60
Radius insert	22X16X5	1,2,3,4,5		45°	● C044M220AASA	20,60
Spur	14X14X2	2,3,5			● C040M14020AA	2,40
Ogive clamp. system	Ø10X11,5XM6SX	1,4,5			● WOG04	4,50
Clamping wedge	21X13X10	1,4			● ETASS131021P1	12,60
Clamping wedge	6X10X10	2,3			● ETASS06	7,20
Clamping wedge	26X13X10	5			● ETASS131026P2	11,70
Spur screw	M5X6	2,3,5			● WV028	3,00
Bevel/Radius screw	M5X20	1,4,5			● WVTPSM05X20	1,00
Bevel/Radius screw	M5X8	2,3			● WV013	3,00
Wedge screw	M6X18	1,4,5			● WV033	3,00
Wedge screw	M5X10	2,3			● WV015	3,00

NOTE △ Utensili non a magazzino, quantità minima d'ordine: 1 pezzo.
Tools not ready in stock minimum order quantity: 1 piece.

Il prezzo include coltelli, anelli e 3 chiavi di regolazione.
The price included knives, spacing collars and 3 screwdrivers.

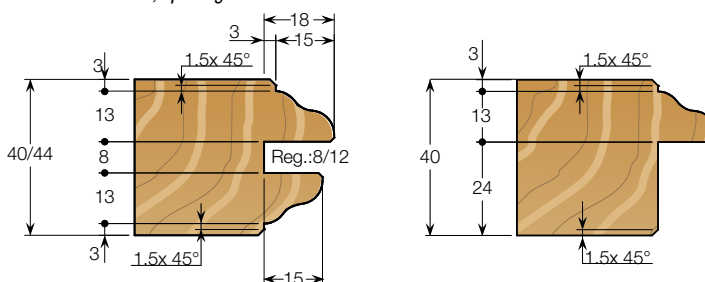

T216

HW Set of tools for inside door's counter profiles



Gruppi per controprofilo di porte e portoncini sagomati • Costruite con corpo in acciaio bonificato • Coltelli in HW a fissaggio meccanico • Le teste in quanto componibili permettono la realizzazione di 6 diversi profili di svariate misure • Lavorano su macchine toupie, scorniatrici e squadatrici

Profiled (counter profiles) cutters set for inside door production • Body in hardened and tempered steel • HW turnover knives • The cutterhead as modular allow the creation of 6 different profiles of various sizes • To mount on toupie, moulding machines and tenoning machines

Z=2

● = Ready in stock ■ = Delivery time 20 working days △ = On request

Nr	D	S	Z	V	S1	F	Code	€
7	320	25	2	2	2	50	△ T216M3202508	512,00
8	314	25	2	2	2	50	△ T216M3142509	576,40
9	284	30	2	2	2	50	△ T216M2843010	512,00
10	50	100				30	△ B0300100AAAR	175,40

Spec. T216M99

SPARE PARTS

Type	Dimensions	Nr	Prof.	R	Code	€
Profile knife	25X30X2	7	A	△	C216M2530C7A	25,00
Profile knife	25X30X2	7	B	△	C216M2530C7B	25,00
Profile knife	25X30X2	7	C	△	C216M2530C7C	25,00
Profile knife	25X30X2	7	D	△	C216M2530C7D	25,00
Profile knife	25X30X2	7	E	△	C216M2530C7E	25,00
Profile knife	25X30X2	7	F	△	C216M2530C7F	25,00
Profile knife	25X30X2	8	A	△	C216M2530C8A	25,00
Profile knife	25X30X2	8	B	△	C216M2530C8B	25,00
Profile knife	25X30X2	8	C	△	C216M2530C8C	25,00
Profile knife	25X30X2	8	D	△	C216M2530C8D	25,00
Profile knife	25X30X2	8	E	△	C216M2530C8E	25,00
Profile knife	25X30X2	8	F	△	C216M2530C8F	25,00
Reversible knife	30X12X1,5	9		●	C020M30012AB	3,40
Radius insert	22X16X5	7,8,9		3	● C044M220R30A	20,60
Radius insert	22X16X5	7,8,9		45°	● C044M220AASA	20,60
Spur	14X14X2	7,8,9			● C040M14020AA	2,40
Ogive clamp. system	10X11,5XM6SX	7,8,9			● WOG04	4,50
Clamping wedge	21X13X10	7,8			● ETASS131021P1	12,60
Clamping wedge	26X13X10	9			● ETASS131026P2	11,70
Spur screw	M5X6	7,8,9			● WV028	3,00
Spur screw	M5X8	9			● WV013	3,00
Bevel/Radius screw	M6X15	7,8,9			● WV040	3,00
Wedge screw	M6X18	7,8,9			● WV033	3,00

NOTE △ Utensili non a magazzino, quantità minima d'ordine: 1 pezzo.
Tools not ready in stock minimum order quantity: 1 piece.

Il prezzo include coltelli, anelli e 2 chiavi di regolazione.
The price included knives, spacing collars and 2 screwdrivers.

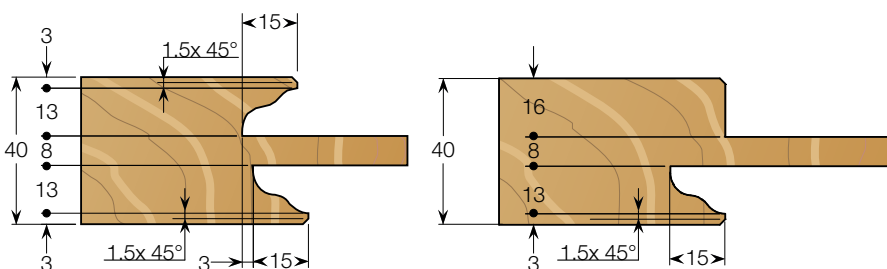

TAGLIO / SEZIONATURA
SAWING

DIAMANTE
DIAMOND

FRESATURA
CUTTING

PANTOGRAFATURA
ROUTING

FORATURA
BORING

MANDRINI / ATTACCHI
CHUCKS & CLAMPING SYSTEM

RICAMBI E LAVORAZIONI SUPP.
SPARE PARTS & ADD. WORKING

T216 HW Set of tools with bead recovering profile

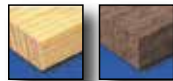

Gruppi per recupero listello di porte e portoncini sagomati • Costruite con corpo in acciaio bonificato • Coltelli in HW a fissaggio meccanico • Lavorano su macchine toupie, scorniciatrici e squadratrici

Profiled tool set for bead recovering • Body in hardened and tempered steel • HW turnover knives • To mount on toupie, moulding machines and tenoning machines

Z=32+2 ● = Ready in stock ■ = Delivery time 20 working days △ = On request

Nr	D	S	Z	V	S1	F	Code	€
11	169	15			2	30	△ T216M1691511	289,20
12	200	3,2	32			30	△ LC20M2003207	70,00

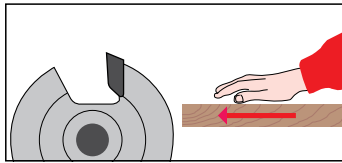
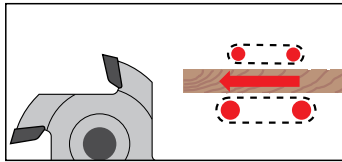
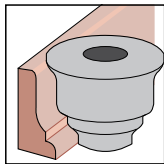
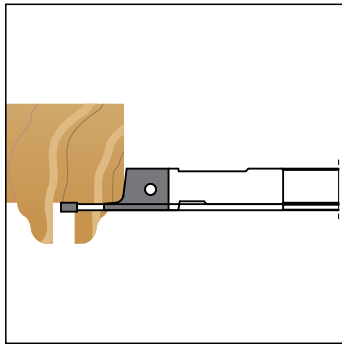
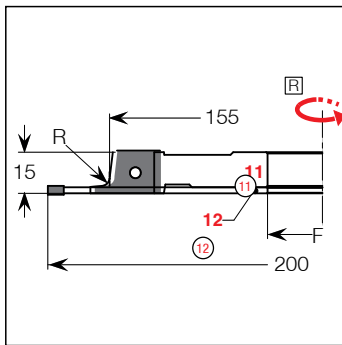

SPARE PARTS

Type	Dimensions	Nr	Prof.	R	Code	€
Profiled knife	15X20X32	11		3	△ C216M152011A	25,00
Profiled knife	15X20X2	11	45°		△ C216M152011B	25,00
Wedge	12X13X10	11			● ETASS131012P	10,80
Ogive clamp. system	Ø10X11,5XM6SX	11			● WOG04	4,50
Wedge screw	M6X18	11			● WV033	3,00

NOTE △ Utensili non a magazzino, quantità minima d'ordine: **1 pezzo.**
Tools not ready in stock minimum order quantity: **1 piece.**

Il prezzo include coltelli e 1 chiave di regolazione.
The price included knives and 1 screwdriver.

TAGLIO / SEZIONATURA
SAWING

DIAMANTE
DIAMOND

FRESATURA
CUTTING

PANTOGRAFATURA
ROUTING

FORATURA
BORING

MANDRINI / ATTACCHI
CHUCKS & CLAMPING SYSTEM

RICAMBI E LAVORAZIONI SUPP.
SPARE PARTS & ADD. WORKING

Set multiprofilo per antine

Werkzeuggarnitur für Möbeltüren

Profil portes de meuble et menuiserie

Комплект фрез для мебельной обвязки

T218

HW Multiprofile cutterheads set for kitchen cabinet

TAGLIO / SEZIONATURA
SAWING

DIAMANTE
DIAMOND

FRESATURA
CUTTING

PANTOGRAFATURA
ROUTING

FORATURA
BORING

MANDRINI / ATTACCHI
CHUCKS & CLAMPING SYSTEM

RICAMBI E LAVORAZIONI SUPP.
SPARE PARTS & ADD. WORKING

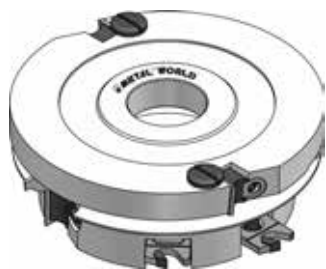
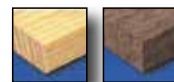

Gruppo composto da 2 teste componibili con coltelli intercambiabili per la produzione di antine • Spessore minimo 22 massimo 27 • Prodotto in 5 tipi diversi di profilo • Lavorano su macchine toupie

Set composed of 2 cutterheads with interchangeable knives for kitchen cabinet doors • From 22 to 27 thickness of profile • With 5 different profiles available • Can be used on toupie machine

Z=2

● = Ready in stock ■ = Delivery time 20 working days ▲ = On request

Nr	D	S	Z	I	R	F	Code	€
1	140	15	2		2	30	▲ T218M1401501	262,00
2	140	30	2	2+2		30	▲ T218M1403002	407,00

Spec.							T218M99	
-------	--	--	--	--	--	--	---------	--

SPARE PARTS

Type	Dimensions	Mod.	Prof.	Code	€
Reversible knife	15X12X1,5	1		● C020M15012AA	2,40
Profile knife	30X26,2X2	2	1	▲ C218M3026201	27,00
Profile knife	30X26,2X2	2	2	▲ C218M3026202	27,00
Profile knife	30X26,2X2	2	3	▲ C218M3026203	27,00
Profile knife	30X26,2X2	2	4	▲ C218M3026204	27,00
Profile knife	30X26,2X2	2	5	▲ C218M3026205	27,00
Clamping wedge	12X13X10	1		● ETASS131012P	10,80
Clamping wedge	26X13X10	2		● ETASS131026P2	11,70
Screw	M6X18	1		● WV033	3,00
Screw	M10X22	2		● WV032	3,00
Ogive cl. system	10X11,5XM6 SX	1		● WOG04	4,50
Ogive cl. system	15X13,5XM10 SX	2		● WOG01	5,40
"T" allen key	Esag. 3	1		● ACHET03AAAAA	7,40
"T" allen key	Esag. 5	2		● ACHET05AAAAA	9,20

NOTE ▲ Utensili non a magazzino, quantità minima d'ordine: **1 pezzo.**
Tools not ready in stock minimum order quantity: **1 piece.**

Il prezzo include coltelli, anelli e 2 chiavi di regolazione.
The price included knives, spacing collars and 2 screwdrivers.

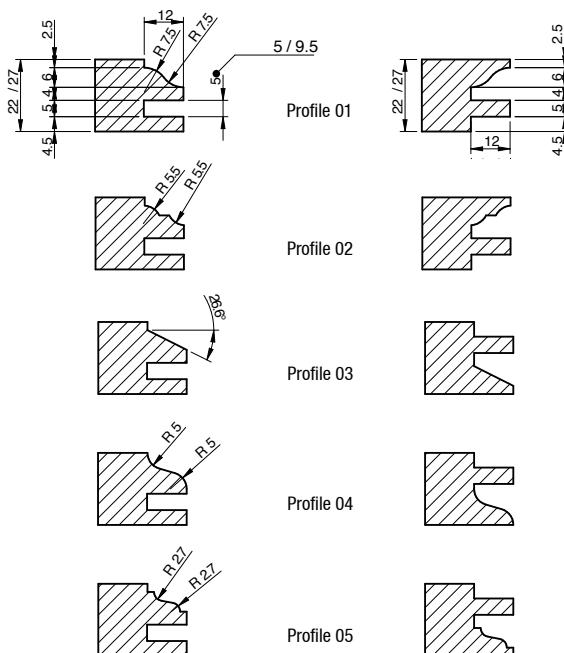
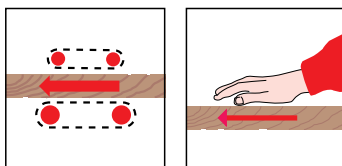
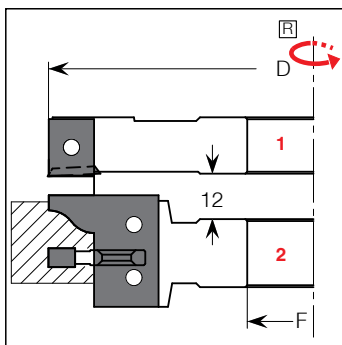
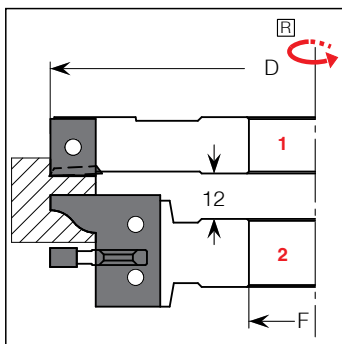



T219

HW Adjustable jointing cutterheads

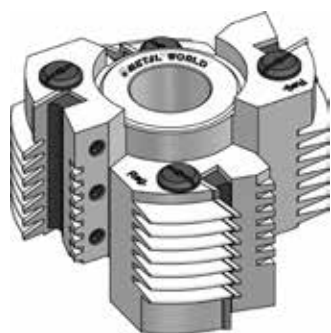
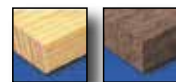

Costruite con corpo in acciaio bonificato • Coltelli in HW a fissaggio meccanico • Indicate per l'esecuzione di giunzioni con parte profilata fissa • Da montare su macchine toupie e scorniatrici

Body in hardened and tempered steel • HW turnover knives • Indicated for the execution of joints with a fixed profiled part • To mount on toupie and moulding machines

Z=2+2

● = Ready in stock ■ = Delivery time 20 working days △ = On request

D	S	A min	A max	F	Code	€
140	40	30	48	40	■ T219M14040AA	551,60
140	60	48	84	40	■ T219M14040AB	605,80

Spec.					T219M99	
-------	--	--	--	--	---------	--

SPARE PARTS

Type	Dimensions	Code	€
Profil knife	40X25X2	● C219M402502A	30,00
Profil knife	60X25X2	● C219M602502A	36,00
Clamping wedge	36X10X10	● ETASS36	12,60
Clamping wedge	56X10X10	● ETASS56	15,00
Screw	M8X16	● WV031	3,00
"T" allen key	Esag. 4	● ACHET04AAAAA	8,20

NOTE △ Utensili non a magazzino, quantità minima d'ordine: **1 pezzo.**
Tools not ready in stock minimum order quantity: **1 piece.**

Il prezzo include coltelli, anelli e 1 chiave di regolazione.
The price included knives, spacing collars and 1 screwdriver.

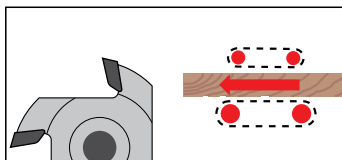
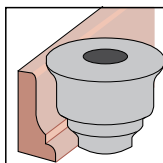
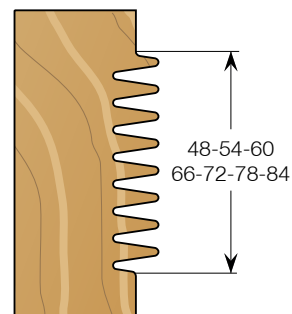
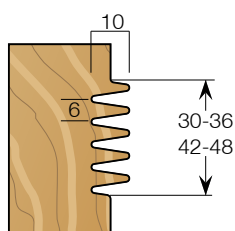
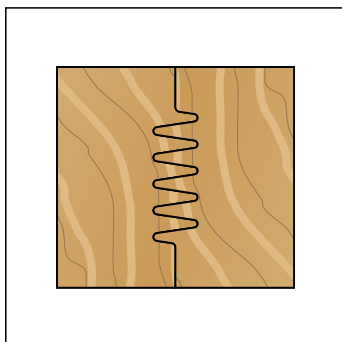
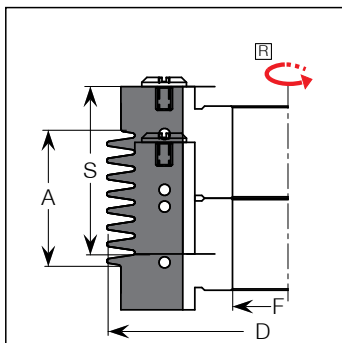
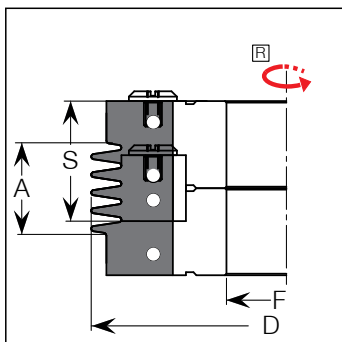

TAGLIO / SEZIONATURA
SAWING

DIAMANTE
DIAMOND

FRESATURA
CUTTING

PANTOGRAFATURA
ROUTING

FORATURA
BORING

MANDRINI / ATTACCHI
CHUCKS & CLAMPING SYSTEM

RICAMBI E LAVORAZIONI SUPP.
SPARE PARTS & ADD. WORKING

T206

HS / HW Cutterheads for profiled knives

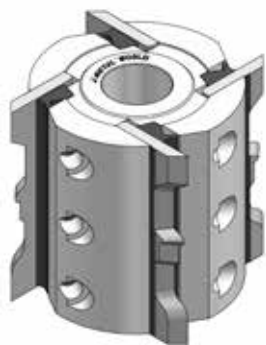

Costruite con corpo in acciaio bonificato • 4 coltelli in HS/HW zigrinati (spessore 8 mm)* • Adatte per la lavorazione di legni massicci • Da montare su macchine scorniciatrici in generale

Body in hardened and tempered steel • 4 HS/HW knurled turnover knives (thickness 8 mm)* • Suitable for working solid wood • Can be used on moulding machines

Z=4

● = Ready in stock ■ = Delivery time 20 working days △ = On request

D	S	F	Code	€
122	60	40	■ T2060BABA0AX	199,60
122	80	40	■ T2060BBBA0AX	239,60
122	100	40	■ T2060BCBA0AX	278,40
122	130	40	■ T2060BDBA0AX	337,80
122	150	40	■ T2060BEBA0AX	377,80
122	180	40	■ T2060BFBA0AX	436,20
122	230	40	■ T2060BGBA0AX	534,40
137	60	50	■ T2060CABA0AX	227,80
137	80	50	■ T2060CBBA0AX	274,60
137	100	50	■ T2060CCBA0AX	316,40
137	130	50	■ T2060CDBA0AX	377,80
137	150	50	■ T2060CEBA0AX	433,20
137	180	50	■ T2060CFBA0AX	503,40
137	230	50	■ T2060CGBA0AX	593,80

Spec.			T206099	
-------	--	--	---------	--

SPARE PARTS

Type	Dimensions	Per S	Code	€
Clamping wedge	58X24X11	60	● ETASS1124058	16,20
Clamping wedge	78X24X11	80	● ETASS1124078	19,60
Clamping wedge	98X24X11	100	● ETASS1124098	21,60
Clamping wedge	128X24X11	130	● ETASS1124128	24,40
Clamping wedge	148X24X11	150	● ETASS1124148	26,40
Clamping wedge	178X24X11	180	● ETASS1124178	29,40
Clamping wedge	228X24X11	230	● ETASS1124228	34,20
Screw	M10X20		● WV053	1,00
"T" allen key	Esag. 5		● ACHET05AAAAA	9,20

* Coltelli non inclusi, su richiesta possono essere forniti profilati o grezzi (ref. pag. 542,543,544)
 * Knives are not included, on request they are supplied profiled or not profiled (see pag. 542,543,544).

NOTE

■ Utensili non a magazzino, quantità minima d'ordine: **1 pezzo**.
 Tools not ready in stock minimum order quantity: **1 piece**.

Il prezzo include 1 chiave di regolazione.
 The price included 1 screwdriver.

T206H HS / HW Hydro cutterheads for profiled knives

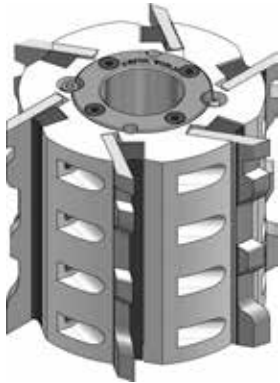
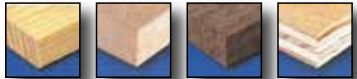

Costruite con corpo in acciaio bonificato • Coltelli in HS/HW zigrinati (spessore mm 8) * • Sistema hydro che consente un perfetto accoppiamento tra l'utensile e l'albero macchina • Adatte per la lavorazione di legni massicci • Da montare su macchine scorniciatrici in generale

Body in hardened and tempered steel • HS/HW knurled turnover knives (thickness 8 mm)* • Hydro bush system for a perfect joint between the tool and the spindle of the machine • Suitable for working solid wood • Can be used on moulding machines

● = Ready in stock ■ = Delivery time 20 working days △ = On request

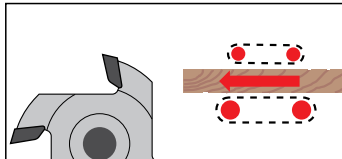
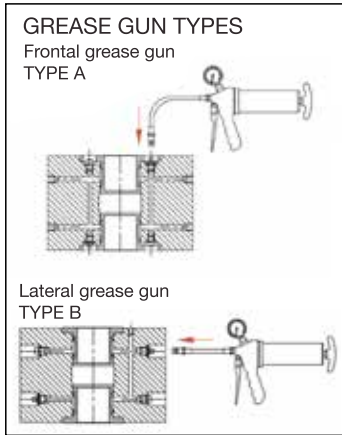
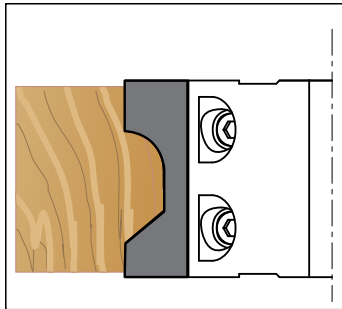
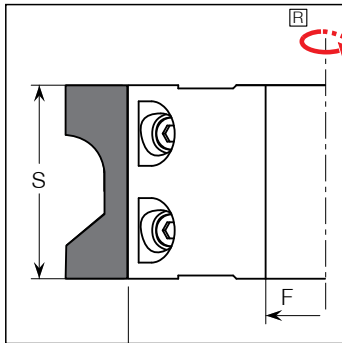

NOTE
 ■ Utensili non a magazzino, quantità minima d'ordine: **1 pezzo**.
 Tools not ready in stock minimum order quantity: **1 piece**.

Il prezzo include 2 chiavi di regolazione.
 The price included 2 screwdrivers.

D	S	Z	F Max	Code Type A	Code Type B	€
137	80	4	40	■ T2060CBBAAAX	■ T2060CBBABAX	717,40
137	100	4	40	■ T2060CCBAAAX	■ T2060CCBABAX	802,20
137	130	4	40	■ T2060CDBAAAX	■ T2060CDBABAX	917,00
137	150	4	40	■ T2060CEBAAAX	■ T2060CEBABAX	1.015,40
137	180	4	40	■ T2060CFBAAAX	■ T2060CFBABAX	1.139,80
137	230	4	40	■ T2060CGBAAAX	■ T2060CGBABAX	1.293,60
150	80	4	50	■ T2060DBBAAAX	■ T2060DBBABAX	745,60
150	100	4	50	■ T2060DCBAAAX	■ T2060DCBABAX	833,20
150	130	4	50	■ T2060DDBAAAX	■ T2060DDBABAX	956,00
150	150	4	50	■ T2060DEBAAAX	■ T2060DEBABAX	1.058,20
150	180	4	50	■ T2060DFBAAAX	■ T2060DFBABAX	1.191,40
150	230	4	50	■ T2060DGBAAAX	■ T2060DGBABAX	1.352,00
150	80	6	50	■ T2060DBCAAAX	■ T2060DBCABAX	931,60
150	100	6	50	■ T2060DCCAAAX	■ T2060DCCABAX	1.041,60
150	130	6	50	■ T2060DDCAAAX	■ T2060DDCABAX	1.194,40
150	150	6	50	■ T2060DECAAAX	■ T2060DECABAX	1.322,80
150	180	6	50	■ T2060DFCAAAX	■ T2060DFCABAX	1.488,40
150	230	6	50	■ T2060DGC AAAX	■ T2060DGCABAX	1.689,80
163	80	8	50	■ T2060EBDAAAX	■ T2060EBDABAX	1.118,40
163	100	8	50	■ T2060ECDAAAX	■ T2060ECDABAX	1.250,80
163	130	8	50	■ T2060EDDAAAX	■ T2060EDDABAX	1.432,80
163	150	8	50	■ T2060EEDAAAX	■ T2060EEDABAX	1.587,60
163	180	8	50	■ T2060EFDAAAX	■ T2060EFDABAX	1.786,20
163	230	8	50	■ T2060EGDAAAX	■ T2060EGDABAX	2.026,60

Spec.		T206099	T206099
-------	--	---------	---------

SPARE PARTS

Type	Dimensions	For S	For Z	Code	€
Clamping wedge	78X19X15	80	4	● ETASS1915078	18,00
Clamping wedge	98X19X15	100	4	● ETASS1915098	19,80
Clamping wedge	128X19X15	130	4	● ETASS1915128	22,50
Clamping wedge	148X19X15	150	4	● ETASS1915148	24,30
Clamping wedge	178X19X15	180	4	● ETASS1915178	27,00
Clamping wedge	228X19X15	230	4	● ETASS1915228	31,50
Clamping wedge	78X24X11	80	6/8	● ETASS1124078	19,60
Clamping wedge	98X24X11	100	6/8	● ETASS1124098	21,60
Clamping wedge	128X24X11	130	6/8	● ETASS1124128	24,40
Clamping wedge	148X24X11	150	6/8	● ETASS1124148	26,40
Clamping wedge	178X24X11	180	6/8	● ETASS1124178	29,40
Clamping wedge	228X24X11	230	6/8	● ETASS1124228	34,20
Screw	M10X20			● WV053	1,00
"T" allen key	Esag. 5			● ACHET05AAAAA	9,20
Pompa hydro				● WAGREASEPUMP	940,40

* Coltelli non inclusi, su richiesta possono essere forniti profilati o grezzi (ref. pag. 542,543,544)
 * Knives are not included, on request they are supplied profiled or not profiled (see pag. 542,543,544).

TAGLIO / SEZIONATURA SAWING
 DIAMANTE DIAMOND
 FRESATURA CUTTING
 PANTOGRAFATURA ROUTING
 FORATURA BORING
 MANDRINI / ATTACCHI CHUCKS & CLAMPING SYSTEM
 RICAMBI E LAVORAZIONI SUPP. SPARE PARTS & ADD. WORKING



Teste portacoltelli sagomati per Weing Powerlock

Profil-Messerköpfe Powerlock für Weing HSK

Porte-outils à profiler pour fers crantés pour Weing Powerlock

Головки со сменными ножами для станков Weing

TAGLIO / SEZIONATURA SAWING

DIAMANTE DIAMOND

FRESATURA CUTTING

PANTOGRAFATURA ROUTING

FORATURA BORING

MANDRINI / ATTACCHI CHUCKS & CLAMPING SYSTEM

RICAMBI E LAVORAZIONI SUPP. SPARE PARTS & ADD. WORKING

T206W

HS / HW Cutterheads for profiled knives for Powerlock



Costruite con corpo in acciaio bonificato • Coltelli in HS/HW zigrinati (spessore mm. 8)* • Attacco POWERLOCK per macchine Weing e SCM • Indicate per la lavorazione di legni massicci

Body in hardened and tempered steel • HS/HW knurled turnover knives (thickness 8 mm)* • POWERLOCK shank for Weing and SCM machines • Suitable for working solid wood

● = Ready in stock ■ = Delivery time 20 working days △ = On request

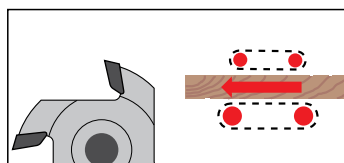
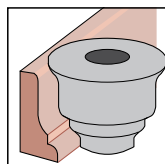
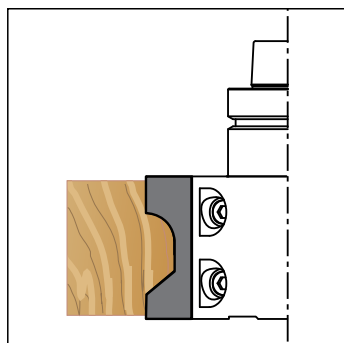
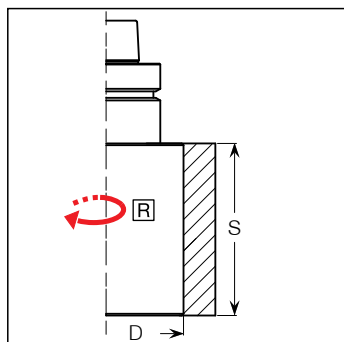

D	S	Z	Left code	Right code	€
90	60	2	■ T2060AAAAL	■ T2060AAAAR	428,40
90	80	2	■ T2060ABAAL	■ T2060ABAAR	495,40
90	100	2	■ T2060ACAAL	■ T2060ACAAR	577,80
90	130	2	■ T2060ADAAL	■ T2060ADAAR	654,20
90	150	2	■ T2060AEAAL	■ T2060AEAAR	725,80
90	180	2	■ T2060AFAAL	■ T2060AFAAR	869,20
90	230	2	■ T2060AGAAL	■ T2060AGAAR	1.014,00
90	60	4	■ T2060AABAL	■ T2060AABAR	534,60
90	80	4	■ T2060ABBAL	■ T2060ABBAR	619,00
90	100	4	■ T2060ACBAL	■ T2060ACBAR	680,60
90	130	4	■ T2060ADBAL	■ T2060ADBAR	769,40
90	150	4	■ T2060AEBAL	■ T2060AEBAR	853,60
90	180	4	■ T2060AFBAL	■ T2060AFBAR	1.023,20
90	230	4	■ T2060AGBAL	■ T2060AGBAR	1.193,00
Spec.			T206099L	T206099R	

SPARE PARTS

Type	Dimensions	Per S	Code	€
Clamping wedge	58X24X11	60	● ETASS1124058	16,20
Clamping wedge	78X24X11	80	● ETASS1124078	19,60
Clamping wedge	98X24X11	100	● ETASS1124098	21,60
Clamping wedge	128X24X11	130	● ETASS1124128	24,40
Clamping wedge	148X24X11	150	● ETASS1124148	26,40
Clamping wedge	178X24X11	180	● ETASS1124178	29,40
Clamping wedge	228X24X11	230	● ETASS1124228	34,20
Screw	M10X20		● WV053	1,00
"T" allen key	Esag. 5		● ACHET05AAAAA	9,20

* Coltelli non inclusi, su richiesta possono essere forniti profilati o grezzi (ref. pag. 542,543,544)

* Knives are not included, on request they are supplied profiled or not profiled (see pag. 542,543,544).

NOTE

■ Utensili non a magazzino, quantità minima d'ordine: **1 pezzo**.
Tools not ready in stock minimum order quantity: **1 piece**.

Il prezzo include 1 chiave di regolazione.
The price included 1 screwdriver.



T208

HW Spiral cutterheads

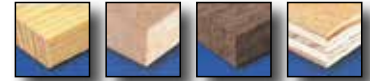

Costruite con corpo in acciaio bonificato o in lega leggera • Coltelli con 4 lati taglienti • Indicate per la lavorazione di legni massicci medio-duri e duri • Ottima finitura • Indicate per medie asportazioni • Forniscono alte prestazioni • Basso inquinamento acustico

Body in hardened and tempered steel or in light alloy • Turnover knives with 4 cutting edges • Suitable for working medium-hard and hard wood • Excellent finish • Indicated for medium chip removal • High performance • Low noise

TAGLIO / SEZIONATURA
SAWING

DIAMANTE
DIAMOND

FRESATURA
CUTTING

PANTOGRAFATURA
ROUTING

FORATURA
BORING

MANDRINI / ATTACCHI
CHUCKS & CLAMPING SYSTEM

RICAMBI E LAVORAZIONI SUPP.
SPARE PARTS & ADD. WORKING

2 PRINCIPLES CUTTING

● = Ready in stock ■ = Delivery time 20 working days △ = On request

D	S	F	Div.	Z	R	Steel code	Light alloy code	€
80	88	30	4	16	2	■ T208MEABA0AX	■ T208MEABA0BX	389,40
80	108	30	4	20	2	■ T208MEBAA0AX	■ T208MEBAA0BX	497,60
100	98	30	4	18		■ T208MAABA0AX	■ T208MAABA0BX	525,80
100	128	30	4	24		■ T208MACBA0AX	■ T208MACBA0BX	593,80
125	98	40	4	18		■ T208MBABBOAX	■ T208MBABB0BX	533,40
125	128	40	4	24		■ T208MBCBBOAX	■ T208MBCBB0BX	599,60
125	180	40	4	34		■ T208MBDBBOAX	■ T208MBDBB0BX	817,80
125	232	40	4	44		■ T208MECAA0AX	■ T208MECAA0Bx	980,40

3 PRINCIPLES CUTTING

D	S	F	Div.	Z	Steel code	Light alloy code	€
125	98	40	6	27	■ T208MBACBOAX	■ T208MBACB0BX	658,00
125	128	40	6	36	■ T208MBBCBOAX	■ T208MBBCB0BX	790,40
125	180	40	6	51	■ T208MBDCBOAX	■ T208MBDCB0BX	1.045,40
125	232	40	6	66	■ T208MBECBOAX	■ T208MBECB0BX	1.314,20
140	98	40	6	27	■ T208MCACBOAX	■ T208MCACB0BX	669,80
140	128	40	6	36	■ T208MCBCBOAX	■ T208MCBCB0BX	789,20
140	180	40	6	51	■ T208MCDCBOAX	■ T208MCDCB0BX	1.068,80
140	232	40	6	66	■ T208MCECBOAX	■ T208MCECB0BX	1.343,40

Spec.					T208M99	T208M99	
-------	--	--	--	--	---------	---------	--

SPARE PARTS

Type	Dimensions	Code	€
Curved knife	15X15X2,5	● C040M15025AA	5,20
TPS knife	M5X10	● WV056	3,00
"T" Torx key	Torx20	● ACHTC20AAAAA	12,60

NOTE

■ Utensili non a magazzino, quantità minima d'ordine: **1 pezzo.**
Tools not ready in stock minimum order quantity: **1 piece.**

Il prezzo include coltelli e 1 chiave di regolazione.
The price included knives and 1 screwdriver.

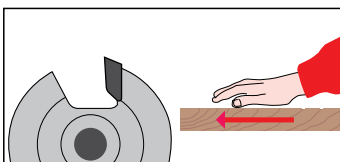
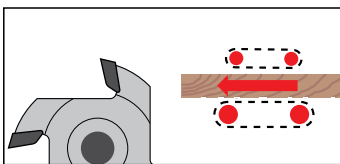
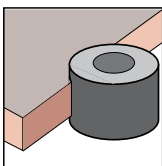
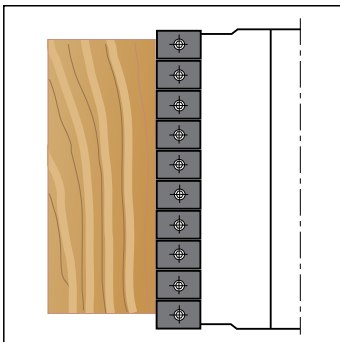
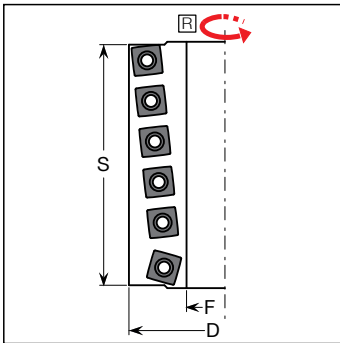

Teste portacoltelli elicoidali con attacco HSK 85 WS Powerlock

Spiral-Messerköpfe mit HSK 85 WS Powerlock

Porte-outils hélicoïdal de rabotage avec HSK 85 WS Powerlock

Строгальные многоножевые стальные головки HSK 85 WS Powerlock

T208W

HW Spiral cutterheads for HSK 85 WS "Powerlock system"



Costruite con corpo in acciaio bonificato • Attacco HSK POWERLOCK • Coltelli con 4 lati taglienti • Indicate per la lavorazione di legni massicci medio, medio-duri e duri • Indicate per medie asportazioni • Ottima finitura • Forniscono alte prestazioni • Basso inquinamento acustico • Indicate per macchine sorniatrici WEINIG e SCM

Body in hardened and tempered steel • Turnover knives with 4 cutting edges • **POWERLOCK shank** • Suitable for working medium-hard and hard wood • Excellent finish • Indicated for medium chip removal • High performance • Low noise • Indicated for molding machines WEINIG and SCM

2 PRINCIPLES CUTTING

● = Ready in stock ■ = Delivery time 20 working days △ = On request

D	S	Div.	Z	Left code	Right code	€
100	100	4	18	■ T208MAABOWAL	■ T208MAABOWAR	771,00
100	130	4	24	■ T208MACBOWAL	■ T208MACBOWAR	893,60
100	182	4	34	■ T208MADBOWAL	■ T208MADBOWAR	1.130,20
100	233	4	44	■ T208MAEBOWAL	■ T208MAEBOWAR	1.366,60

Spec.				T208M99L	T208M99R	
-------	--	--	--	----------	----------	--

SPARE PARTS

Type	Dimensions	Code	€
Curved knife	15X15X2,5	● C040M15025AA	5,20
TPS knife	M5X10	● WV056	3,00
"T" Torx key	Torx20	● ACHTC20AAAAA	12,60

NOTE

■ Utensili non a magazzino, quantità minima d'ordine: **1 pezzo**.
Tools not ready in stock minimum order quantity: **1 piece**.

Il prezzo include coltelli e 1 chiave di regolazione.
The price included knives and 1 screwdriver.

TAGLIO / SEZIONATURA
SAWING

DIAMANTE
DIAMOND

FRESATURA
CUTTING

PANTOGRAFATURA
ROUTING

FORATURA
BORING

MANDRINI / ATTACCHI
CHUCKS & CLAMPING SYSTEM

RICAMBI E LAVORAZIONI SUPP.
SPARE PARTS & ADD. WORKING

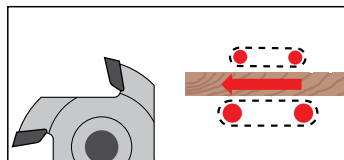
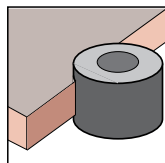
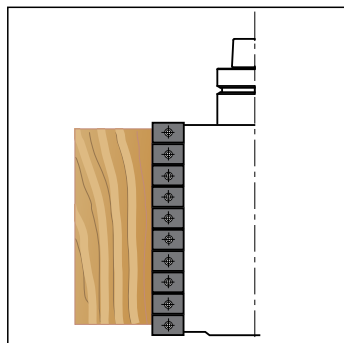
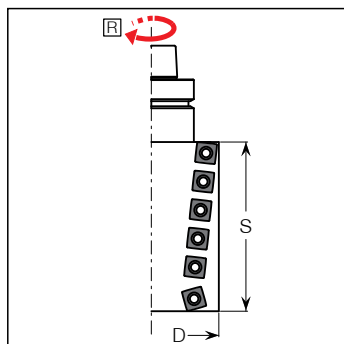

T209

HW Spiral cutterheads

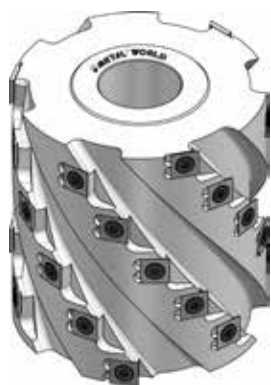

Costruite con corpo in acciaio bonificato o in lega leggera • Dotate di coltelli con 4 taglienti • Adatte per grosse asportazioni • Indicate per la lavorazione di legni massicci medio – duri e duri • Forniscono alte prestazioni a basso rumore

Body in hardened and tempered steel or in light alloy • Turnover knives with 4 cutting edges • Suitable for working medium-hard and hard wood • Good finish • Indicated for medium chip removal • Good performance • Low noise

2 PRINCIPLES CUTTING

● = Ready in stock ■ = Delivery time 20 working days △ = On request

D	S	F	Div.	Z	Steel code	Light alloy code	€
100	98	30	4	16	■ T209HAABAAAR	■ T209HAAAABAR	333,40
100	134	30	4	22	■ T209HABBAAR	■ T209HABAABAR	366,00
125	98	40	4	16	■ T209HBABBAAR	■ T209HBAABBAR	339,60
125	134	40	4	22	■ T209HBBBAAR	■ T209HBBABBAR	370,80
125	182	40	4	30	■ T209HBCBAAR	■ T209HBCABBAR	515,60
125	206	40	4	34	■ T209HDBBAAR	■ T209HDBABBAR	579,40
125	230	40	4	38	■ T209HBEBBAAR	■ T209HBEABBAR	635,60

3 PRINCIPLES CUTTING

D	S	d	Div.	Z	Steel code	Light alloy code	€
125	98	40	6	24	■ T209HBACBAAR	■ T209HBABBBAR	433,00
125	134	40	6	33	■ T209HBCBAAR	■ T209HBBBBBAR	487,60
125	182	40	6	45	■ T209HCCBAAR	■ T209HCBBBBAR	660,40
125	206	40	6	51	■ T209HDCBAAR	■ T209HDBBBBAR	750,80
125	230	40	6	57	■ T209HECBAAR	■ T209HEBBBAR	839,60
140	98	40	6	24	■ T209HCACBAAR	■ T209HCABBBAR	442,40
140	134	40	6	33	■ T209HCCBAAR	■ T209HCBBBBAR	500,00
140	182	40	6	45	■ T209HCCCBAAR	■ T209HCCBBBAR	679,20
140	206	40	6	51	■ T209HCDCBAAR	■ T209HCDBBBAR	771,00
140	230	40	6	57	■ T209HCECBAAR	■ T209HCEBBBAR	862,80

Spec.					T209M99	T209M99	
-------	--	--	--	--	---------	---------	--

SPARE PARTS

Type	Dimensions	Code	€
Spur	14X14X2	● C040M14020AA	2,40
TPS screw	M5X10	● WV056	3,00
"T" Torx key	Torx20	● ACHTT20AAAAA	14,60

NOTE

■ Utensili non a magazzino, quantità minima d'ordine: **1 pezzo**.
Tools not ready in stock minimum order quantity: **1 piece**.

Il prezzo include coltelli e 1 chiave di regolazione.
The price included knives and 1 screwdriver.

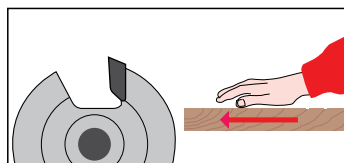
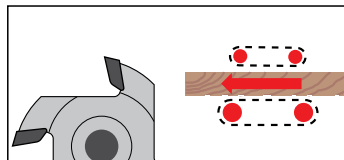
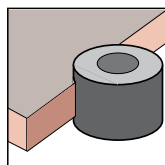
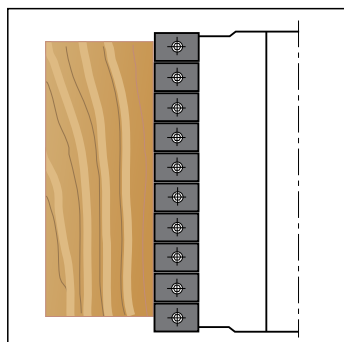
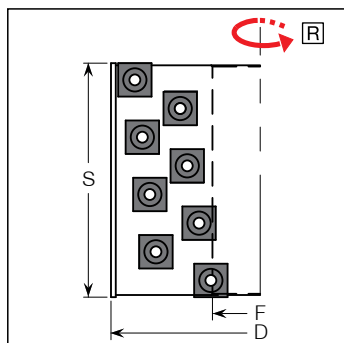

Teste portacoltelli per piattabande

Abblatt-Messerköpfe

Porte-outils plate-bande

Филеочные фрезерные головки

T220

HW Panel raising cutterheads



Costruite con corpo in acciaio bonificato • Coltelli in HW a fissaggio meccanico • Adatte per l'esecuzione di specchietti e per pannelli in generale • Da montare su macchine toupie, scorniciatrici

Body in hardened and tempered steel • HW turnover knives • Suitable for working central panel for furniture, panel and etc. • To mount on toupie and moulding machines

● = Ready in stock ■ = Delivery time 20 working days △ = On request

D	S	d	Z	F	Code	€
200	20	30	2	30	■ T220M20002AR	331,80
200	20	30	3	30	■ T220M20003AR	397,20
200	20	30	2+2	30	● T220M20022AR	462,60
200	20	30	3+3	30	● T220M20033AR	554,60

Spec. T220M99

* In fase di ordine specificare il modello.

* At the order specify the model.

SPARE PARTS

Type	Dimensions	Code	€
Reversible knife	50X12X1,5	● C020M50012AB	4,60
Profile knife	20X20X2	● CS00M2020AAA	20,60
Profile knife	25X25X2	● WCS2525AAAA	22,80
Ogive cl. system	15X13,5XM10sx	● WOG01	5,40
Ogive cl. system	10X11,5XM6sx	● WOG04	4,50
Clamping wedge	14X13X10	● ETASS131014P	10,80
Clamping wedge	46X13X10	● ETASS131046P	14,40
Screw	M5X7X16	● WV017	3,00
Screw	M6X18	● WV033	3,00
Screw	M10X22	● WV032	3,00
"T" allen key	Esag. 3	● ACHETO3AAAAA	7,40
"T" allen key	Esag. 5	● ACHETO5AAAAA	5,60

NOTE

■ Utensili non a magazzino, quantità minima d'ordine: **1 pezzo**.
Tools not ready in stock minimum order quantity: **1 piece**.

Il prezzo include coltelli e 1 chiave di regolazione.
The price included knives and 1 screwdriver.

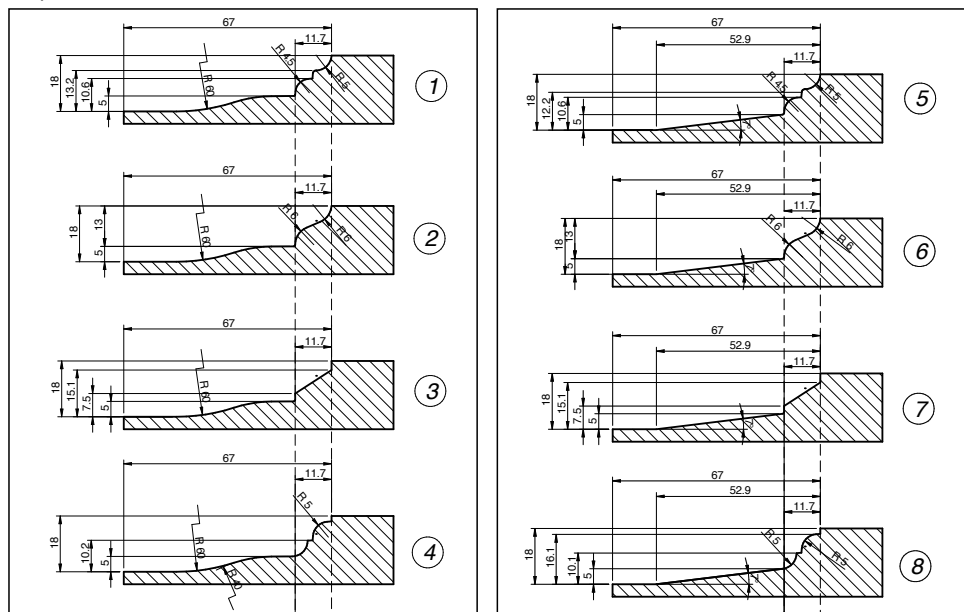

TAGLIO / SEZIONATURA
SAWING

DIAMANTE
DIAMOND

FRESATURA
CUTTING

PANTOGRAFATURA
ROUTING

FORATURA
BORING

MANDRINI / ATTACCHI
CHUCKS & CLAMPING SYSTEM

RICAMBI E LAVORAZIONI SUPP.
SPARE PARTS & ADD. WORKING



T265

HW Set of rounding cutterheads

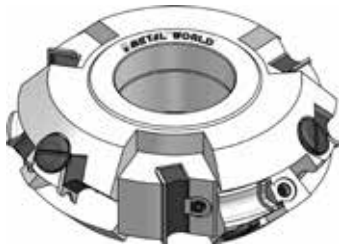

Costruiti con corpi in acciaio bonificato • Coltelli in HW a fissaggio meccanico • Indicati per la lavorazione di bordi raggiati • Adatti per lavorare legni massicci o materiali truciolari • Da montare su macchine toupie, scorniciatrici

Body in hardened and tempered steel • HW turnover knives • Suitable for working profiled edges • Indicated for processing solid wood or chipboards • To mount on toupie and moulding machines

Z=3+3+3

● = Ready in stock ■ = Delivery time 20 working days △ = On request

D	S	R	F	Mod.	F	Code	€
125	30		30	B	40	■ T265M12530AR	180,20
125	50		30	B	40	■ T265M12550AR	208,40
180	30		30	B	40	■ T265M18030AR	206,40
180	50		30	B	40	■ T265M18050AR	235,60
125	13	2-3-4	30	A-C	40	■ T265M12513AR	337,80
125	20	5-6-7-8	30	A-C	40	■ T265M12520AR	359,20
125	26	9-10-11-12	30	A-C	40	■ T265M12526AR	379,80
180	13	2-3-4	30	A-C	40	■ T265M18013AR	355,40
180	20	5-6-7-8	30	A-C	40	■ T265M18020AR	376,80
180	26	9-10-11-12	30	A-C	40	■ T265M18026AR	398,20

Spec. T265M99

SPARE PARTS

Type	Dimensions	R	Code	€
Reversible knife	13X16X2	2	■ SC265M021316	21,00
Reversible knife	13X16X2	3	■ SC265M031316	21,00
Reversible knife	13X16X2	4	■ SC265M041316	21,00
Reversible knife	20X21X2	5	■ SC265M052021	23,00
Reversible knife	20X21X2	6	■ SC265M062021	23,00
Reversible knife	20X21X2	7	■ SC265M072021	23,00
Reversible knife	20X21X2	8	■ SC265M082021	23,00
Reversible knife	26X24X2	9	■ SC265M092624	27,00
Reversible knife	26X24X2	10	■ SC265M102624	27,00
Reversible knife	26X24X2	11	■ SC265M112624	27,00
Reversible knife	26X24X2	12	■ SC265M122624	27,00
Reversible knife	30X12X1,5		● C020M30012AB	3,40
Reversible knife	50X12X1,5		● C020M50012AB	4,60
Clamping wedge	12X13X10	2-3-4	● ETASS121310P	10,80
Clamping wedge	18X16X10	5-6-7-8	● ETASS181610P	14,40
Clamping wedge	24X18X10	9-10-11-12	● ETASS241810P	16,20
Clamping wedge	26X13X10		● ETASS131026P	11,70
Clamping wedge	46X13X10		● ETASS131046P	14,40
Ogive cl. system	15X13,5XM10sx	5÷12 - B	● WOG01	5,40
Ogive cl. system	10X11,5XM6sx	2-3-4	● WOG04	4,50
Screw	M6X18	2-3-4	● WV033	3,00
Screw	M10X22	5÷12 - B	● WV032	3,00
"T" allen key	Esag. 3	2-3-4	● ACHET03AAAAA	7,40
"T" allen key	Esag. 5	5÷12 - B	● ACHET05AAAAA	9,20

*Coltello raggio R/Knives radius R	B range with S=30	B range with S=50
R2-R3-R4	4-30	24-50
R5-R6-R7-R8	10-40	30-60
R9-R10-R11-R12	-48	36-68

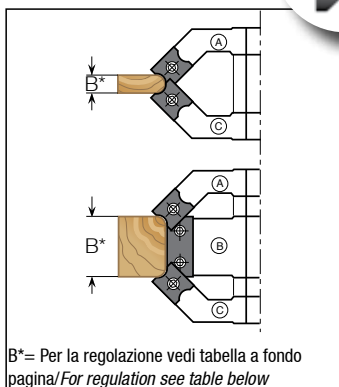
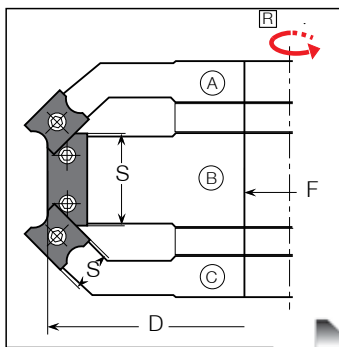

B* = Per la regolazione vedi tabella a fondo pagina/For regulation see table below

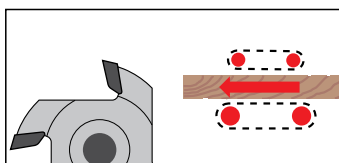
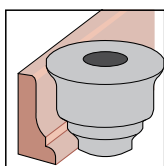

NOTE

■ Utensili non a magazzino, quantità minima d'ordine: **1 pezzo**.
Tools not ready in stock minimum order quantity: **1 piece**.

Il prezzo include coltelli, anelli e 1 chiave di regolazione.
The price included knives, spacing collars and 1 screwdriver.

TAGLIO / SEZIONATURA SAWING

DIAMANTE DIAMOND

FRESATURA CUTTING

PANTOGRAFATURA ROUTING

FORATURA BORING

MANDRINI / ATTACCHI CHUCKS & CLAMPING SYSTEM

RICAMBI E LAVORAZIONI SUPP. SPARE PARTS & ADD. WORKING

T300

HW Cutterheads for joints

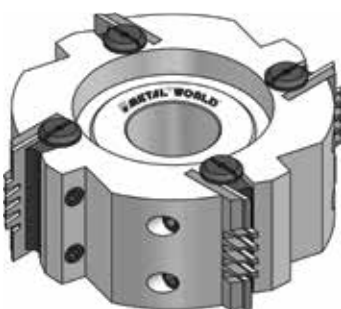
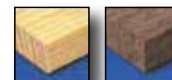

Costruite con corpo in acciaio bonificato • Coltelli in HW a fissaggio meccanico • Indicate per l'esecuzione di giunzioni con parte profilata fissa • Da montare su macchine toupie e scorniciatrici • Profili A / B / C adatti per giunzioni lungovena • Profili D / E / F adatti per giunzioni controvena

Body in hardened and tempered steel • HW turnover knives • Indicated for the execution of joints with a fixed profiled part • To mount on toupie and moulding machines • A/B/C profiles suitable for jointing along the grain • D/E/F for jointing cross the grain

Z=4

● = Ready in stock ■ = Delivery time 20 working days △ = On request

D	S	F	Mod.	Code	€
136	40	30	A	■ T300M13640AA	405,00
136	50	30	B	■ T300M13650BA	447,80
136	50	30	C	■ T300M13650CA	459,60
140	40	30	D	■ T300M14040DA	436,20
140	50	30	E	■ T300M14050EA	479,00
140	50	30	F	■ T300M14050FA	490,60

Spec.

T300M99

SPARE PARTS

Type	Dimensions	Mod.	Code	€
Body	120X40		■ T300C120040A	140,00
Body	120X50		■ T300C120050A	150,00
Profile knife	50X20X2	B	■ C300MPROFILB	30,00
Profile knife	40X20X2	A	■ C300MPROFILA	26,80
Profile knife	50X20X2	C	■ C300MPROFILC	30,00
Profile knife	40X22X2	D	■ C300MPROFILD	31,00
Profile knife	50X22X2	E	■ C300MPROFILE	35,00
Profile knife	50X22X2	F	■ C300MPROFILF	38,00
Back knife	40X28X4	A	■ CC30040284AA	28,00
Back knife	50X28X4	B	■ CC30050284AB	31,00
Back knife	50X28X4	C	■ CC30050284AC	33,00
Back knife	40X30X4	D	■ CC30040304AD	32,00
Back knife	50X30X4	E	■ CC30050304AE	35,00
Back knife	50X30X4	F	■ CC30050304AF	36,00
Clamping wedge	36X10X10		● ETASS36	12,60
Clamping wedge	46X10X10		● ETASS46	14,40
Screw	M8X16		● WV031	3,00
"T" allen key	Esag. 4		● ACHETO4AAAAA	8,20
Screw	M6X8,5		● WV042	3,00

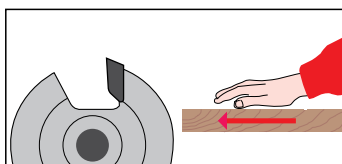
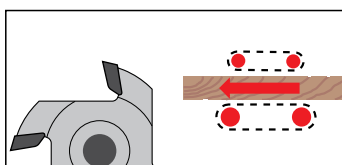
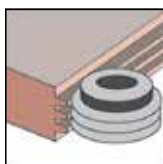
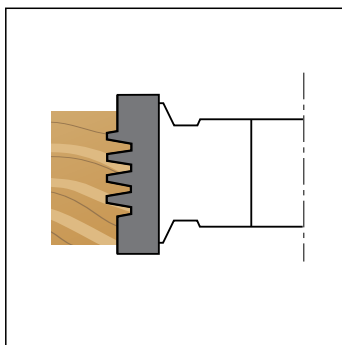
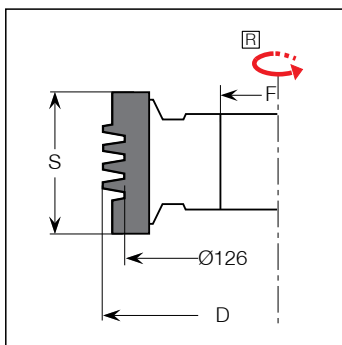

NOTE

■ Utensili non a magazzino, quantità minima d'ordine: 1 pezzo.
Tools not ready in stock minimum order quantity: 1 piece.

Il prezzo include coltelli e 1 chiave di regolazione.
The price included knives and 1 screwdriver.

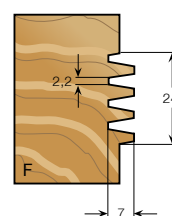
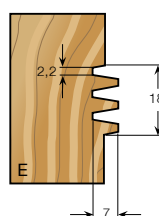
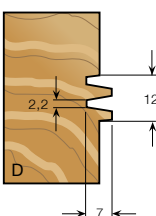
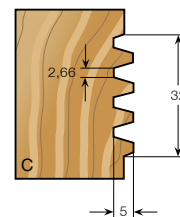
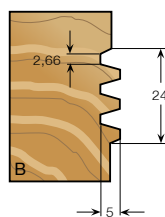
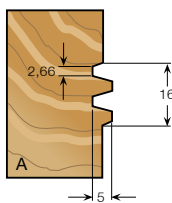



T310

HW 45° mitre joint cutterhead

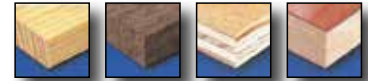

Teste sagomate costruite con corpo in acciaio bonificato • 3 coltelli in HW a fissaggio meccanico • Indicate per lavorazioni su toupie, scorniciatrici etc.

Profiled cutter heads with steel hardened and tempered body • 3 HW turnover knives • To use on toupie and moulding machine

Z=3

● = Ready in stock ■ = Delivery time 20 working days △ = On request

D	S	F	Code	€
160	30	30	■ T310M16030AA	518,00
200	60	30	■ T310M20060AA	650,20
Spec.			T310M99	

SPARE PARTS

Type	Dimensions	Code	€
Profile knife	30X25X2	■ C310M302502A	24,40
Profile knife	60X25X2	■ C310M602502A	36,00
Insert	34X16X5	● C046M05AAAAAR	25,80
Clamping wedge	13X10X26	● ETASS131026P2	11,70
Clamping wedge	13X10X56	● ETASS131056P	15,50
Screw	M10X22	● WV032	3,00
Ogive clamping system	15X13,5XM10SX	● WOG01	5,40
Insert's screw	M6X15	● WV040	3,00
Positioning screw	M5X7 ø16	● WV017	3,00
"T" allen key	Esag. 5	● ACHET05AAAAA	9,20

NOTE

■ Utensili non a magazzino, quantità minima d'ordine: **1 pezzo**.
Tools not ready in stock minimum order quantity: **1 piece**.

Il prezzo include coltelli e 2 chiavi di regolazione.
The price included knives and 2 screwdrivers.

ESEMPI DI LAVORAZIONE EXAMPLES OF PROCESSING

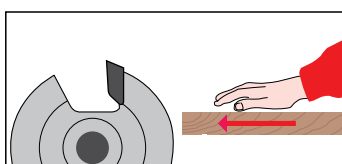
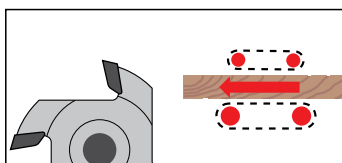
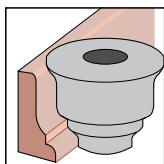
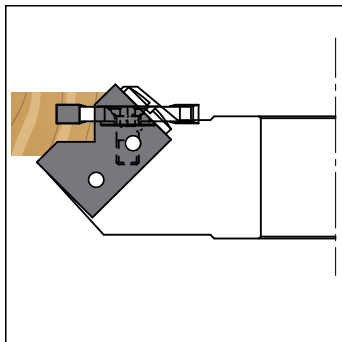
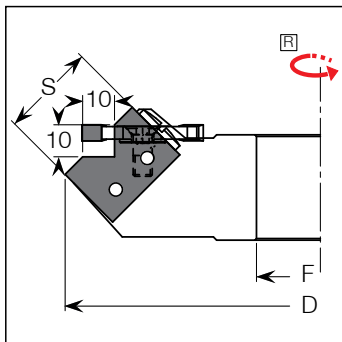
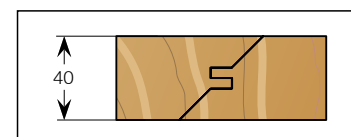
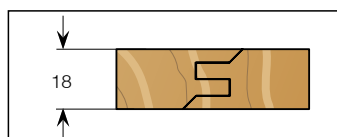
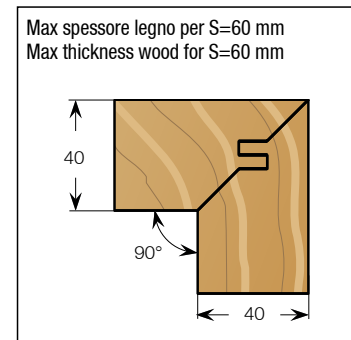
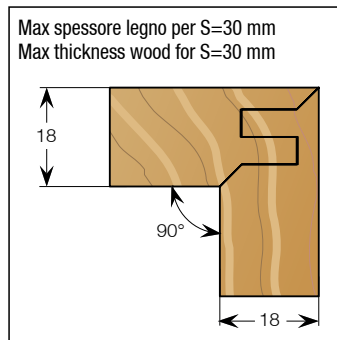

TAGLIO / SEZIONATURA
SAWING

DIAMANTE
DIAMOND

FRESATURA
CUTTING

PANTOGRAFATURA
ROUTING

FORATURA
BORING

MANDRINI / ATTACCHI
CHUCKS & CLAMPING SYSTEM

RICAMBI E LAVORAZIONI SUPP.
SPARE PARTS & ADD. WORKING

Teste portacoltelli per parchetti e perline

Wendeplatten Nut-und Federsatz

Porte-outils réglables pour parquet et lambris

Комплекты фрез для доски пола, паркета и вагонки

T330

HW Tongue and groove cutterheads

TAGLIO / SEZIONATURA
SAWING

DIAMANTE
DIAMOND

FRESATURA
CUTTING

PANTOGRAFATURA
ROUTING

FORATURA
BORING

MANDRINI / ATTACCHI
CHUCKS & CLAMPING SYSTEM

RICAMBI E LAVORAZIONI SUPP.
SPARE PARTS & ADD. WORKING



Costruite con corpo in acciaio bonificato • Coltelli in HW a fissaggio meccanico • Le teste in quanto componibili permettono la realizzazione di 5 diversi profili di svariate misure • Lavorano su macchine toupie, scorniatrici e squadratrici

Body in hardened and tempered steel • HW turnover knives • The cutterhead as modular allow the creation of 5 different profiles of various sizes • To mount on toupie, moulding machines and end tenoning machines

● = Ready in stock ■ = Delivery time 20 working days △ = On request

Nr	D	S	Z	I	R	S1	F	Code	€
1	160	20	4			2	2	40 △ T330M16020AA	294,00
2	147	12	4				40 △ T330M14712AA	216,20	
3	159	20	4			2	2	40 △ T330M15920AA	294,00
4	175	25	4	2			40 △ T330M17525AA	301,80	
5	175	25	4	2			40 △ T330M17525BA	301,80	
6	174	12	4				40 △ T330M17412AA	243,40	
7	174	12	4				40 △ T330M17412BA	243,40	
8	160	20	4		2	2	40 △ T330M16020BA	294,00	
9	195	15	4		2	2	40 △ T330M19515AA	354,40	
10	175	15	4	2			40 △ T330M17515AA	327,20	
11	169	20	4		2	2	40 △ T330M16920AA	303,80	
12	184	25	4	2			40 △ T330M18425AA	303,80	
13	184	18,5	4	2			40 △ T330M18418AA	335,00	

Spec.

T330M99

SPARE PARTS

Type	Dimensions	Nr	Code	€
Reversible knife	12X12X1,5	2,6,7	● C020M12012AA	2,20
Reversible knife	15X12X1,5	9,10,13	● C020M15012AA	2,40
Reversible knife	20X12X1,5	1,3,8,11	● C020M20012AA	2,80
Reversible knife	25X12X1,5	4,5,12	● C020M25012AA	3,60
Insert	4	4,12	● C046M04AAAAAR	25,00
Insert	4	5,10,13	● C046M04AAAAAL	25,00
Bevel	22X16X5	1,3,8,9,11	● C044M220AASA	20,60
Spur	14X14X2	1,3,8,9,11	● C040M14020AA	2,40
Ogive clamp. system	10X11,5XM6sx	1,2,3,4,5,6,7,8,9,10,11,12,13	● WOG04	4,50
Clamping wedge	10X13X10	2,6,7	● ETASS131010P	10,80
Clamping wedge	12X13X10	9,10,13	● ETASS131012P	10,80
Clamping wedge	16X13X10	1,3,8,11	● ETASS131016P	10,80
Clamping wedge	21X3X10	4,5,12	● ETASS131021P1	12,60
Spur screw	M5X6	1,3,8,9,11	● WV028	3,00
Screw	M6X18	1,2,3,4,5,6,7,9,10,11,12,13	● WV033	3,00
Screw	M6X15	1,3,4,5,8,9,10,11,12,13	● WV040	3,00

NOTE

■ Utensili non a magazzino, quantità minima d'ordine: **1 pezzo.**
Tools not ready in stock minimum order quantity: **1 piece.**

Il prezzo include coltelli, anelli e 2 chiavi di regolazione.
The price included knives, spacing collars and 2 screwdrivers.



T330 **HW** Tongue and groove cutterheads

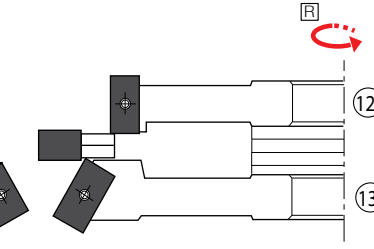
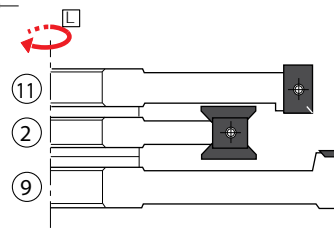
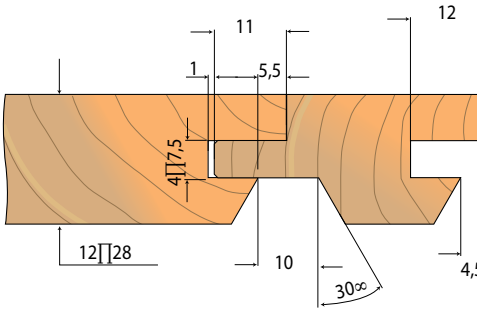
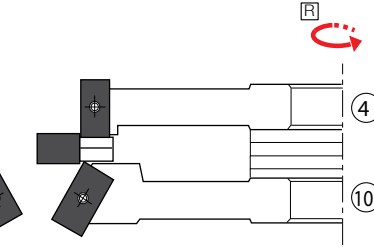
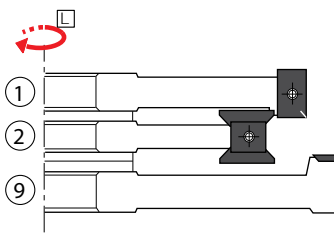
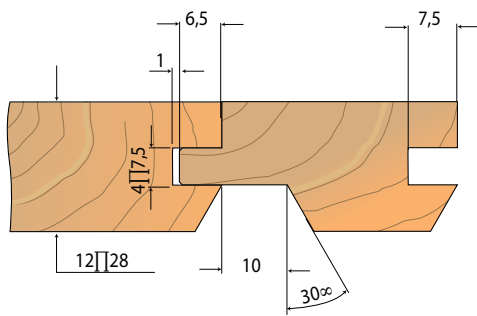
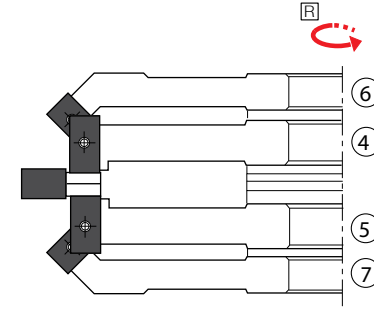
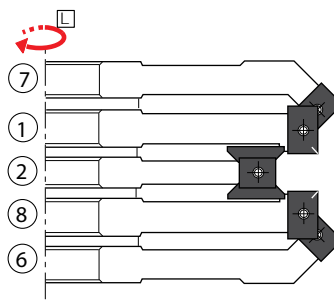
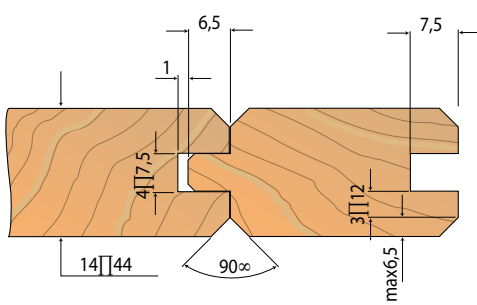
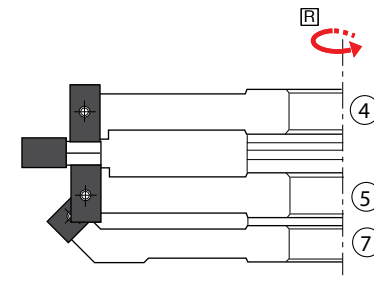
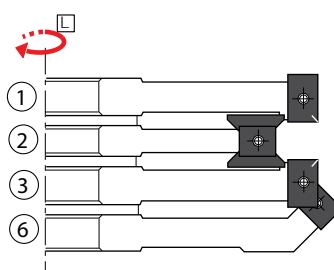
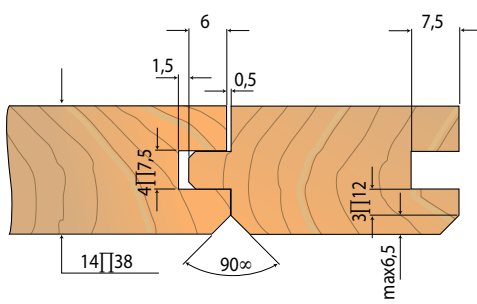
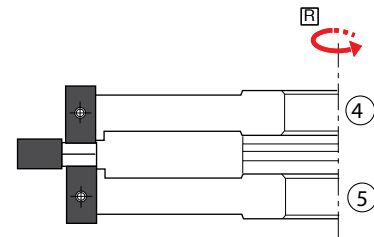
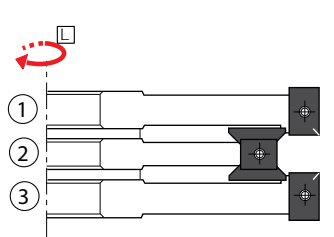
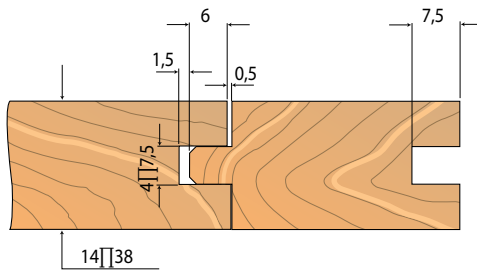

TAGLIO / SEZIONATURA
SAWING

DIAMANTE
DIAMOND

FRESATURA
CUTTING

PANTOGRAFATURA
ROUTING

FORATURA
BORING

MANDRINI / ATTACCHI
CHUCKS & CLAMPING SYSTEM

RICAMBI E LAVORAZIONI SUPP.
SPARE PARTS & ADD. WORKING

Gruppi teste regolabili per spine

Messerkopfsatz für Holzdübel

Jeu de porte-outils pour tenonneuse double

Комплект фрез для двусторонних шипорезных станков

T382

HW Set of cutterheads for tenoning machines

TAGLIO / SEZIONATURA
SAWING

DIAMANTE
DIAMOND

FRESATURA
CUTTING

PANTOGRAFATURA
ROUTING

FORATURA
BORING

MANDRINI / ATTACCHI
CHUCKS & CLAMPING SYSTEM

RICAMBI E LAVORAZIONI SUPP.
SPARE PARTS & ADD. WORKING

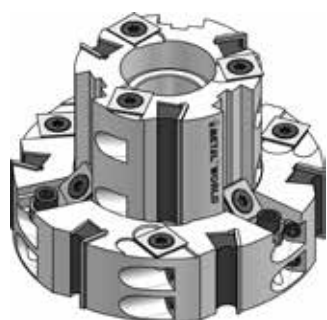

Costruiti con corpo in acciaio bonificato • Coltelli in HW a fissaggio meccanico • Indicati per l'esecuzione di spine • Da montare su macchine tenonatrici doppie

Body in hardened and tempered steel • HW turnover knives • Indicated to execute wooden pins • To mount on double end tenoning machines

Z=6+3 V=3+3

● = Ready in stock ■ = Delivery time 20 working days △ = On request

Mod.	D	S	F	Z	V	Chamfer	Left Code	Right Code	€
A+B	115	80	25	6+3	3+3	3	■ G382M11580AL	■ G382M11580AR	818,60
A	115	30	68	6	3		■ T382M115030L	■ T382M115030R	
B	70	50	25	3	3	3	■ T382M070050L	■ T382M070050R	
Spec.							T382M99L	T382M99R	

SPARE PARTS

Type	Dimensions	Code	€
Reversible knife	30X12X1,5	● C020M30012AB	3,40
Reversible knife	50X12X1,5	● C020M50012AB	4,60
Spur	14X14X2	● C040M14020AA	2,40
Clamping wedge	26X10X10	● ETASS26	10,80
Clamping wedge	46X10X10	● ETASS46	14,40
Bevel Clamping wedge	12X15X25	● STASST3824	32,40
Spur screw	M5X6	● WV028	3,00
Knife screw	M8X12	● WV036	1,00
Knife screw	M8X14	● WV037	1,00
Bevel spur screw	M5X10	● WV038	3,00
Spur for hogging	M8X20	● WV039	2,00
"T" allen key	Esag.4	● ACHET04AAAAA	8,20
"T" Torx key	Torx20	● ACHTT20AAAAA	14,60

NOTE

■ Utensili non a magazzino, quantità minima d'ordine: **1 pezzo.**
Tools not ready in stock minimum order quantity: **1 piece.**

Il prezzo include coltelli e 3 chiavi di regolazione.
The price included knives and 3 screwdrivers.

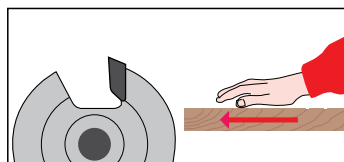
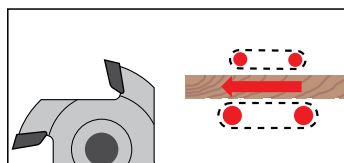
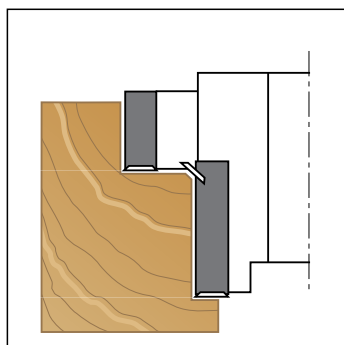
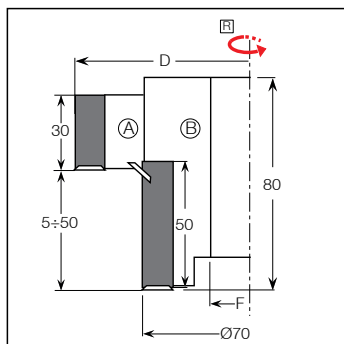

T384 HW Set of cutterheads for tenoning machines

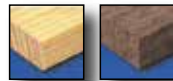

TAGLIO / SEZIONATURA
SAWING

DIAMANTE
DIAMOND

FRESATURA
CUTTING

PANTOGRAFATURA
ROUTING

FORATURA
BORING

MANDRINI / ATTACCHI
CHUCKS & CLAMPING SYSTEM

RICAMBI E LAVORAZIONI SUPP.
SPARE PARTS & ADD. WORKING



Costruiti con corpo in acciaio bonificato • Coltelli in HW a fissaggio meccanico • Indicati per l'esecuzione di spine • Da montare su macchine tenonatrici singole

Body in hardened and tempered steel • HW turnover knives • Indicated to execute wooden pins • To mount on single end tenoning machines

Z=6+3 V=3+3

● = Ready in stock ■ = Delivery time 20 working days △ = On request

Mod.	D	S	F	Z	V	Chamfer	Code	€
A+B	135	80	30	6+3	3+3	3	■ G384M13580AA	929,60
A	135	30	88	6	3		■ T384M135030R	
B	90	80	30	3	3	3	■ T384M090030R	

Spec. T384M99

SPARE PARTS

Type	Dimensions	Code	€
Reversible knife	30X12X1,5	● C020M30012AB	3,40
Reversible knife	50X12X1,5	● C020M50012AB	4,60
Spur	14X14X2	● C040M14020AA	2,40
Clamping wedge	26X10X10	● ETASS26	10,80
Clamping wedge	46X10X10	● ETASS46	14,40
Bevel Clamping wedge	12X15X25	● STASST3824	32,40
Spur screw	M5X6	● WV028	3,00
Knife screw	M8X12	● WV036	1,00
Knife screw	M8X14	● WV037	1,00
Bevel spur screw	M5X10	● WV038	3,00
Spur for hogging	M8X20	● WV039	2,00
"T" allen key	Esag.4	● ACHET04AAAAA	8,20
"T" Torx key	Torx20	● ACHTT20AAAAA	14,60

NOTE

■ Utensili non a magazzino, quantità minima d'ordine: **1 pezzo.**
Tools not ready in stock minimum order quantity: **1 piece.**

Il prezzo include coltelli e 3 chiavi di regolazione.
The price included knives and 3 screwdrivers.

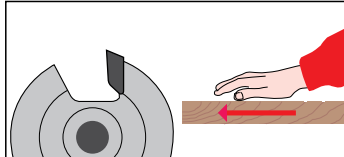
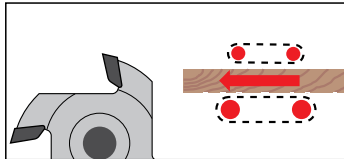
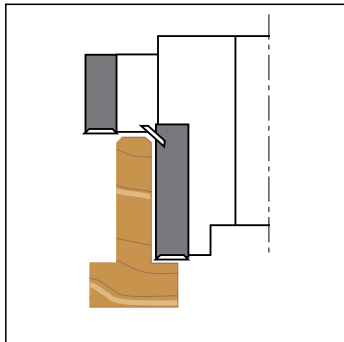
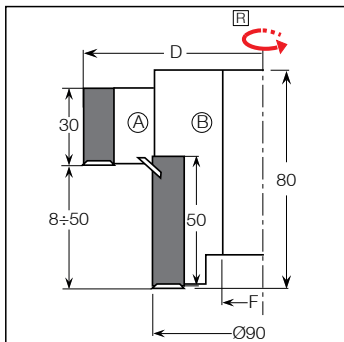

Teste elicoidali
a coltellini

Spiralförmiger-Messerköpfe
mit Achswinkel

Porte-outils hélicoïdal
à plaquettes réversibles

Фрезы радиусные для
кромочных станков

T386

HW Elical-plan cutterheads

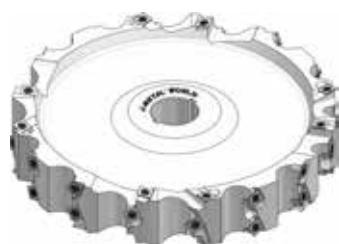

Costruite con corpo in lega leggera • Coltelli con 4 lati taglienti • Indicate per la lavorazione di legni teneri / medi / medio-duri • Buona finitura • Indicate per medie asportazioni • Forniscono alte prestazioni • Basso inquinamento acustico

Body in light alloy • Turnover knives with 4 cutting edges • Suitable for working soft wood / medium / medium-hard • Good finishing • Indicated for medium chip removal • High performance • Low noise

● = Ready in stock ■ = Delivery time 20 working days △ = On request

D	S	F	Z	Code	€
250	45	45	40	△ T386M250045A	982,20
250	46	45	40	△ T386M250046A	990,80
250	60	45	44	△ T386M250060A	1.051,40
250	80	45	52	△ T386M250080A	1.103,80
250	100	45	60	△ T386M250100A	1.209,20
300	20	45	28	△ T386M300020A	1.031,80
300	40	45	36	△ T386M300040A	1.081,60
300	45	45	40	△ T386M300045A	1.090,20
300	46	45	40	△ T386M300046A	1.099,00
300	50	45	40	△ T386M300050A	1.107,60
300	60	45	44	△ T386M300060A	1.168,20
300	61	45	44	△ T386M300061A	1.179,00
300	80	45	52	△ T386M250080A	1.226,80
300	100	45	60	△ T386M250100A	1.343,40
350	20	55	28	△ T386M350020A	1.146,40
350	25	55	32	△ T386M350025A	1.157,40
350	27	55	32	△ T386M350027A	1.168,20
350	30	55	32	△ T386M350030A	1.179,00
350	35	55	36	△ T386M350035A	1.189,80
350	40	55	36	△ T386M350040A	1.200,60
350	45	55	40	△ T386M350045A	1.211,40
350	57	55	44	△ T386M350057A	1.287,00
350	60	55	44	△ T386M350060A	1.297,80
350	61	55	44	△ T386M350061A	1.308,80
350	80	55	52	△ T386M350080A	1.362,80
350	90	55	56	△ T386M350090A	1.427,60
350	100	55	60	△ T386M350100A	1.492,60

Spec.

T386M99

SPARE PARTS

Type	Dimensions	Code	€
Knife	15X15X2,5	● C040M15025AA	5,20
TPS Knife screw	M5X18	● WV074	3,00
Torx Key	Torx20	● ACHTC20AAAAA	12,60

NOTE

■ Utensili non a magazzino, quantità minima d'ordine: **1 pezzo.**
Tools not ready in stock minimum order quantity: **1 piece.**

Il prezzo include coltelli e 1 chiave di regolazione.
The price included knives and 1 screwdriver.

TAGLIO / SEZIONATURA
SAWING

DIAMANTE
DIAMOND

FRESATURA
CUTTING

PANTOGRAFATURA
ROUTING

FORATURA
BORING

MANDRINI / ATTACCHI
CHUCKS & CLAMPING SYSTEM

RICAMBI E LAVORAZIONI SUPP.
SPARE PARTS & ADD. WORKING

Teste portacoltelli a profilo diritto per bordatrici

Kanten-Füge-Messerköpfe

Porte outils d'affleurance droites

Фрезы с прямыми ножами для кромочных станков

T400

HW Edge banding cutterheads

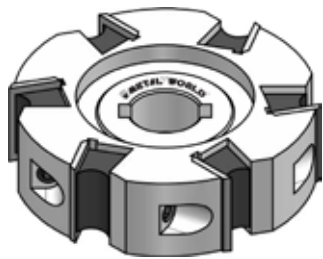
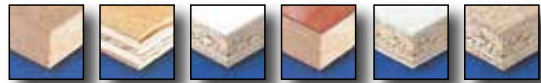

Costruite con corpo in acciaio bonificato • Coltelli in HW a fissaggio meccanico • Corpo simmetrico • Mozzo centrale • Adatte per rifilare bordi melaminici, laminati, nobilitati, impiallacciati • Da montare su macchine BIESSE, HOMAG

Body in hardened and tempered steel • HW turnover knives • Symmetrical body • Central hub • Suitable for trimming melamine, laminates, veneer edges • To mount on BIESSE and HOMAG machines

TO MOUNT ON **BIESSE** EDGE BANDING MACHINES

D	S	S1	F	Z	Code	€
70	20	12	16+2CH	6	T400M70206AB	183,00
80	25	12	16+2CH	6	T400M80256AA	198,60

Spec.					T400M99	
-------	--	--	--	--	---------	--

● = Ready in stock ■ = Delivery time 20 working days △ = On request

SPARE PARTS

Type	Dimensions	Code	€
Reversible knife	20X12X1,5	● C020M20012AA	2,80
Reversible knife	25X12X1,5	● C020M25012AA	3,60
Clamping wedge	18X10X10	● ETASS18	10,00
Clamping wedge	23X10X10	● ETASS23	10,80
Knife screw	M6X12	● WV029	1,00
"T" allen key	Esag. 3	● ACHET03AAAAA	7,40

TO MOUNT ON HOMAG EDGE BANDING MACHINES

D	S	S1	F	Z	Code	€
61	12	10	16+2CH	3	■ T400M61123AA	124,60
61	20	11	16+2CH	3	■ T400M61203AA	130,60
70	20	11	16+2CH	4	■ T400M70204AH	152,00
70	12	10	16+2CH	4	■ T400M70124AA	146,20
70	12	10	16+2CH	6	■ T400M70126AA	175,40
70	20	12	16+2CH	6	■ T400M70206AH	183,00

Spec.					T400M99	
-------	--	--	--	--	---------	--

SPARE PARTS

Type	Dimensions	Code	€
Reversible knife	12X12X1,5	● C020M12012AA	2,20
Reversible knife	20X12X1,5	● C020M20012AA	2,80
Clamping wedge	10X10X10	● ETASS10	8,10
Clamping wedge	18X10X10	● ETASS18	10,00
Knife screw	M6X10	● WV035	1,00
"T" allen key	Esag. 3	● ACHET03AAAAA	7,40

NOTE

■ Utensili non a magazzino, quantità minima d'ordine: **2 pezzi**.
Tools not ready in stock minimum order quantity: **2 pieces**.

Il prezzo include coltelli e 1 chiave di regolazione.
The price included knives and 1 screwdriver.

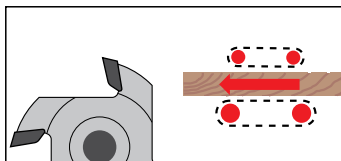
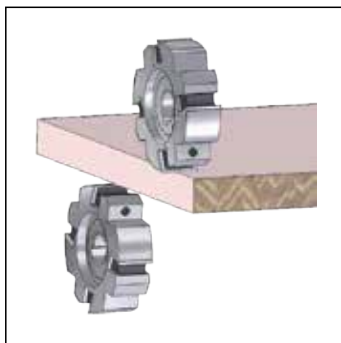
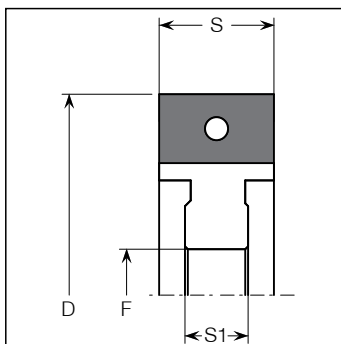

TAGLIO / SEZIONATURA
SAWING

DIAMANTE
DIAMOND

FRESATURA
CUTTING

PANTOGRAFATURA
ROUTING

FORATURA
BORING

MANDRINI / ATTACCHI
CHUCKS & CLAMPING SYSTEM

RICAMBI E LAVORAZIONI SUPP.
SPARE PARTS & ADD. WORKING

Teste portacoltelli a profilo diritto per bordatrici

Kanten-Füge-Messerköpfe

Porte outils d'affleurage droites

Фрезы мультирадиусные для кромочных

T400

HW Edge banding cutterheads



Costruite con corpo in acciaio bonificato • Coltelli in HW a fissaggio meccanico • Corpo simmetrico • Mozzo centrale • Adatte per rifilare bordi melaminici, laminati, nobilitati, impiallacciati • Da montare su macchine BIESSE, HOMAG

Body in hardened and tempered steel • HW turnover knives • Symmetrical body • Central hub • Suitable for trimming melamine, laminates, veneer edges • To mount on BRNDT and IMA machines

TO MOUNT ON BRANDT EDGE BANDING MACHINES

D	S	S1	F	Z	Code	€
70	12	10	16+2CH	4	■ T400M70124AA	146,20
70	12	10	16+2CH	6	■ T400M70126AA	175,40
70	20	12,5	16+2CH	6	■ T400M70206AA	183,00

Spec. T400M99

● = Ready in stock ■ = Delivery time 20 working days △ = On request

SPARE PARTS

Type	Dimensions	Code	€
Reversible knife	12X12X1,5	● C020M12012AA	2,20
Reversible knife	20X12X1,5	● C020M20012AA	2,80
Clamping wedge	10X10X10	● ETASS10	8,10
Clamping wedge	18X10X10	● ETASS18	10,00
Knife screw	M6X12	● WV029	1,00
"T" allen key	Esag. 3	● ACHET03AAAAA	7,40

TO MOUNT ON ZIMA EDGE BANDING MACHINES

D	S	S1	F	Z	Code	€
70	20	12,5	20+2CH	6	■ T400M70206AI	183,00

Spec. T400M99

SPARE PARTS

Type	Dimensions	Code	€
Reversible knife	20X12X1,5	● C020M20012AA	2,80
Clamping wedge	18X10X10	● ETASS18	10,00
Knife screw	M6X12	● WV029	1,00
"T" allen key	Esag. 3	● ACHET03AAAAA	7,40

NOTE

■ Utensili non a magazzino, quantità minima d'ordine: 2 pezzi.
Tools not ready in stock minimum order quantity: 2 pieces.

Il prezzo include coltelli e 1 chiave di regolazione.
The price included knives and 1 screwdriver.

TAGLIO / SEZIONATURA
SAWING

DIAMANTE
DIAMOND

FRESATURA
CUTTING

PANTOGRAFATURA
ROUTING

FORATURA
BORING

MANDRINI / ATTACCHI
CHUCKS & CLAMPING SYSTEM

RICAMBI E LAVORAZIONI SUPP.
SPARE PARTS & ADD. WORKING

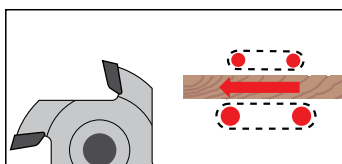
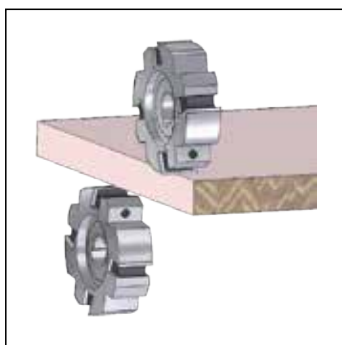
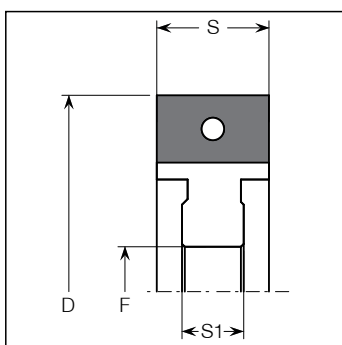

T408 HW Edge banding cutterheads

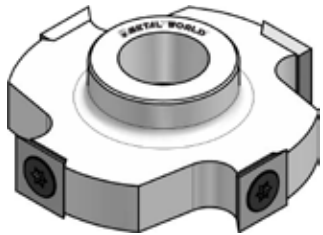
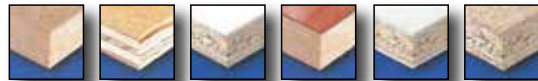

Costruite con corpo in acciaio bonificato • Coltelli in HW a fissaggio meccanico • Adatte per rifilare bordi malaminici, laminati, nobilitati, impiallacciati • **Da montare su macchine HOMAG ed IMA**

Body in hardened and tempered steel • HW turnover knives • Suitable for trimming melamine, laminates, veneer edges • **To mount on SCM machines**

TO MOUNT ON HOMAG AND IMA EDGE BANDING MACHINES

D	S	S1	F	Z	Left Code	Right Code	€
70	14	23	HSK25	4	■ T408M7014AHL	■ T408M7014AHR	189,00

Spec. T408M99
 ● = Ready in stock ■ = Delivery time 20 working days △ = On request

SPARE PARTS

Type	Dimensions	Code	€
Spur	14X14X2	● C040M14020AA	2,40
Knife screw	M5X8	● WV013	3,00
"T" Torx key	Torx20	● ACHTT20AAAAA	14,60

TO MOUNT ON IMA EDGE BANDING MACHINES

D	S	S1	F	Z	Left Code	Right Code	€
70	14	13	20+2CH	4	■ T408M7014AAL	■ T408M7014AAR	165,60

Spec. T408M99

SPARE PARTS

Type	Dimensions	Code	€
Spur	14X14X2	● C040M14020AA	2,40
Knife screw	M5X8	● WV013	3,00
"T" Torx key	Torx20	● ACHTT20AAAAA	14,60

NOTE
 ■ Utensili non a magazzino, quantità minima d'ordine: **2 pezzi.**
 Tools not ready in stock minimum order quantity: **2 pieces.**

Il prezzo include coltelli e 1 chiave di regolazione.
 The price included knives and 1 screwdriver.

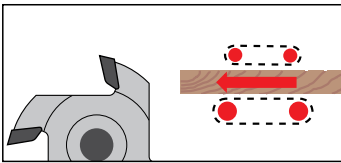
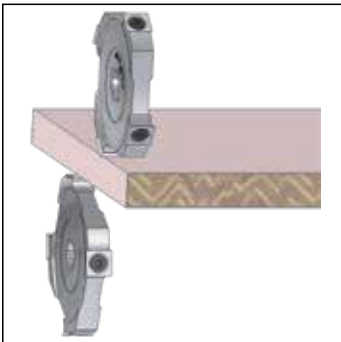
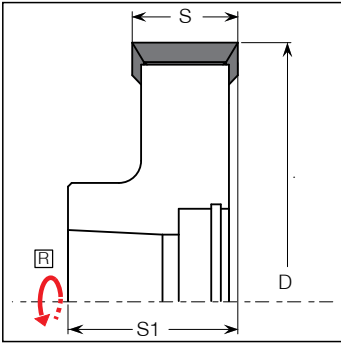

TAGLIO / SEZIONATURA
SAWING

DIAMANTE
DIAMOND

FRESATURA
CUTTING

PANTOGRAFATURA
ROUTING

FORATURA
BORING

MANDRINI / ATTACCHI
CHUCKS & CLAMPING SYSTEM

RICAMBI E LAVORAZIONI SUPP.
SPARE PARTS & ADD. WORKING

Teste portacoltelli a profilo diritto per bordatrici

Kanten-Füge-Messerköpfe

Porte outils d'affleurage droites

Фрезы с прямыми ножами для кромочных станков

T400

HW Edge banding cutterheads

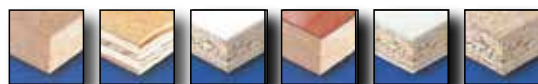

Costruite con corpo in acciaio bonificato • Coltelli in HW a fissaggio meccanico • Corpo simmetrico • Mozzo centrale • Adatte per rifilare bordi melaminici, laminati, nobilitati, impiallacciati • Da montare su macchine BIESSE, HOMAG

Body in hardened and tempered steel • HW turnover knives • Symmetrical body • Central hub • Suitable for trimming melamine, laminates, veneer edges • To mount on BIESSE and HOMAG machines

TO MOUNT ON **scm** EDGE BANDING MACHINES

D	S	S1	F	Z	Code	€
70	12	10	16+2CH	4	■ T400M70124AA	146,20
70	20	11	16+2CH	4	■ T400M70204AA	152,00
72	20	11	16+2CH	4	■ T400M72204AA	155,80
75	20	11	16+2CH	4	■ T400M75204AA	155,80
75	30	11	16+2CH	4	■ T400M75304AA	175,40
80	20	11	16+2CH	4	■ T400M80204AA	165,60
80	30	11	16+2CH	4	■ T400M80304AA	175,40

Spec.

T400M99

● = Ready in stock ■ = Delivery time 20 working days △ = On request

SPARE PARTS

Type	Dimensions	Code	€
Reversible knife	12X12X1,5	● C020M12012AA	2,20
Reversible knife	20X12X1,5	● C020M20012AA	2,80
Reversible knife	30X12X1,5	● C020M30012AB	3,40
Clamping wedge	10X10X10	● ETASS10	8,10
Clamping wedge	16X10X10	● ETASS16	10,40
Clamping wedge	18X10X10	● ETASS18	10,00
Clamping wedge	28X10X10	● ETASS28	10,80
Knife screw	M6X12	● WV029	1,00
"T" allen key	Esag. 3	● ACHET03AAAAA	7,40

NOTE

■ Utensili non a magazzino, quantità minima d'ordine: **2 pezzi**.
Tools not ready in stock minimum order quantity: **2 pieces**.

Il prezzo include coltelli e 1 chiave di regolazione.
The price included knives and 1 screwdriver.

TAGLIO / SEZIONATURA
SAWING

DIAMANTE
DIAMOND

FRESATURA
CUTTING

PANTOGRAFATURA
ROUTING

FORATURA
BORING

MANDRINI / ATTACCHI
CHUCKS & CLAMPING SYSTEM

RICAMBI E LAVORAZIONI SUPP.
SPARE PARTS & ADD. WORKING

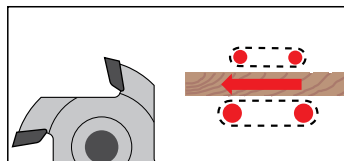
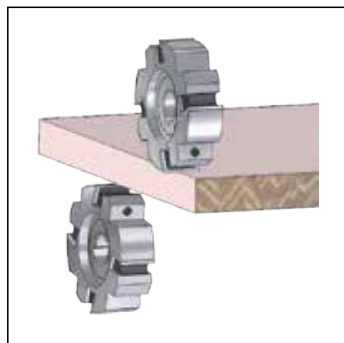
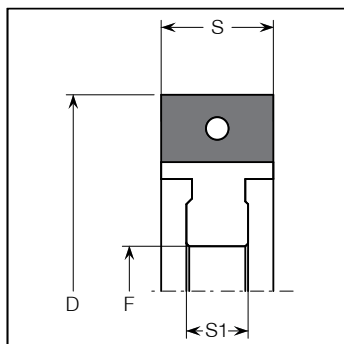

T404 HW Edge banding cutterheads



Costruite con corpo in acciaio bonificato • Coltelli in HW a fissaggio meccanico • Corpo simmetrico • Mozzo centrale • Adatte per rifilare bordi melaminici, laminati, nobilitati, impiallacciati • **Da montare su macchine HOMAG**

Body in hardened and tempered steel • HW turnover knives • Symmetrical body • Central hub • Suitable for trimming melamine, laminates, veneer edges • **To mount on HOMAG machines**

TO MOUNT ON HOMAG EDGE BANDING MACHINES

D	S	S1	F	Z	Code	€
70	14	10	16+2CH	4	■ T404M70144AA	148,00

Spec. T404M99

● = Ready in stock ■ = Delivery time 20 working days △ = On request

SPARE PARTS

Type	Dimensions	Code	€
Spur	14X14X2	● C040M14020AA	2,40
Knife screw	M5X8	● WV013	3,00
"T" Torx key	Torx20	● ACHTT20AAAAA	14,60

NOTE

■ Utensili non a magazzino, quantità minima d'ordine: **2 pezzi.**
Tools not ready in stock minimum order quantity: **2 pieces.**

Il prezzo include coltelli e 1 chiave di regolazione.
The price included knives and 1 screwdriver.

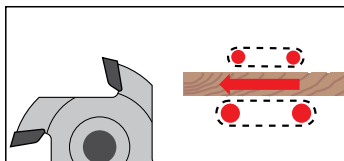
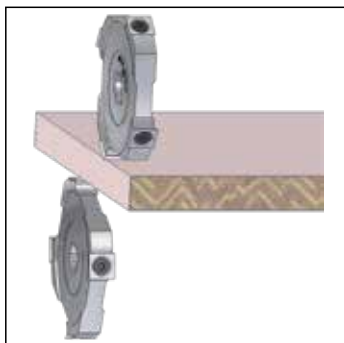
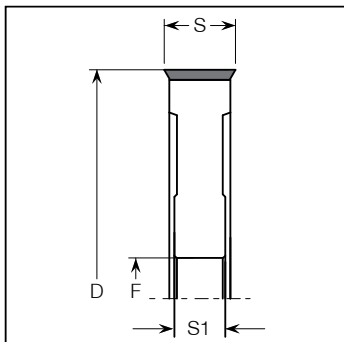

TAGLIO / SEZIONATURA
SAWING

DIAMANTE
DIAMOND

FRESATURA
CUTTING

PANTOGRAFATURA
ROUTING

FORATURA
BORING

MANDRINI / ATTACCHI
CHUCKS & CLAMPING SYSTEM

RICAMBI E LAVORAZIONI SUPP.
SPARE PARTS & ADD. WORKING

Teste portacoltelli
a profilo diritto
per bordatrici

Kanten-Füge-
Messerköpfe

Porte outils d'affleurage
droites

Фрезы
мультирадиусные
для кромочных

T410

HW Edge banding cutterheads

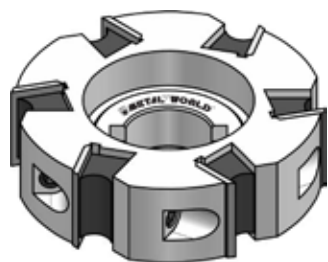

Costruite con corpo in acciaio bonificato • Coltelli in HW a fissaggio meccanico • Mozzo laterale • Adatte per rifilare bordi melaminici, laminati, nobilitati, impiallacciati • **Da montare su macchine HOMAG e BRANDT**

Body in hardened and tempered steel • HW turnover knives • Lateral hub • Suitable for trimming melamine, laminates, veneer edges • **To mount on HOMAG and BRANDT machines**

TAGLIO / SEZIONATURA
SAWING

DIAMANTE
DIAMOND

FRESATURA
CUTTING

PANTOGRAFATURA
ROUTING

FORATURA
BORING

MANDRINI / ATTACCHI
CHUCKS & CLAMPING SYSTEM

RICAMBI E LAVORAZIONI SUPP.
SPARE PARTS & ADD. WORKING

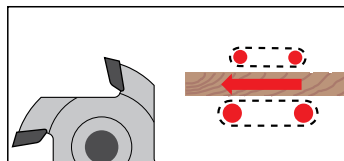
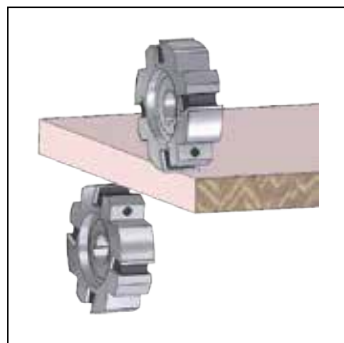
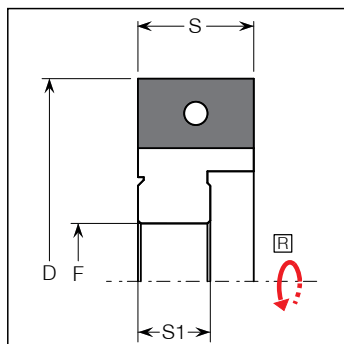

TO MOUNT ON HOMAG EDGE BANDING MACHINES

D	S	S1	F	Z	Left Code	Right Code	€
61	12	10	16+2CH	3	■ T410M61123AL	■ T410M61123AR	124,60
61	20	11	16+2CH	3	■ T410M61203AL	■ T410M61203AR	130,60
70	20	11	16+2CH	4	■ T410M70204BL	■ T410M70204BR	152,00
70	12	10	16+2CH	4	■ T410M70124AL	■ T410M70124AR	146,20
70	12	10	16+2CH	6	■ T410M70126AL	■ T410M70126AR	175,40
70	20	11	20+2CH	6	■ T410M70206AL	■ T410M70206AR	183,00

Spec.	T410M99L	T410M99R
-------	----------	----------

● = Ready in stock ■ = Delivery time 20 working days △ = On request

SPARE PARTS

Type	Dimensions	Code	€
Reversible knife	12X12X1,5	● C020M12012AA	2,20
Reversible knife	20X12X1,5	● C020M20012AA	2,80
Clamping wedge	10X10X10	● ETASS10	8,10
Clamping wedge	18X10X10	● ETASS18	10,00
Knife screw for D.70	M6X12	● WV029	1,00
Knife screw for D.61	M6X10	● WV035	1,00
"T" allen key	Esag. 3	● ACHET03AAAAA	7,40

TO MOUNT ON BRANDT EDGE BANDING MACHINES

D	S	S1	F	Z	Left Code	Right Code	€
70	12	10	16+2CH	4	■ T410M70124AL	■ T410M70124AR	146,20
70	12	10	16+2CH	6	■ T410M70126AL	■ T410M70126AR	175,40
70	20	11	20+2CH	6	■ T410M70206AL	■ T410M70206AR	183,00

Spec.	T410M99L	T410M99R
-------	----------	----------

SPARE PARTS

Type	Dimensions	Code	€
Reversible knife	12X12X1,5	● C020M12012AA	2,20
Reversible knife	20X12X1,5	● C020M20012AA	2,80
Clamping wedge	10X10X10	● ETASS10	8,10
Clamping wedge	18X10X10	● ETASS18	10,00
Knife screw	M6X12	● WV029	1,0
"T" allen key	Esag. 3	● ACHET03AAAAA	7,40

NOTE

■ Utensili non a magazzino, quantità minima d'ordine: **2 pezzi**.
Tools not ready in stock minimum order quantity: **2 pieces**.

Il prezzo include coltelli e 1 chiave di regolazione.
The price included knives and 1 screwdriver.

Teste portacoltelli
a profilo diritto
per bordatrici

Kanten-Füge-
Messerköpfe

Porte outils d'affleurement
droites

Фрезы с прямыми ножами
для кроющих станков



T410

HW Edge banding cutterheads



Costruite con corpo in acciaio bonificato • Coltelli in HW a fissaggio meccanico • Mozzo laterale • Adatte per rifilare bordi melaminici, laminati, nobilitati, impiallacciati • **Da montare su macchine HOMAG e BRANDT**

Body in hardened and tempered steel • HW turnover knives • Lateral hub • Suitable for trimming melamine, laminates, veneer edges • **To mount on IMA and SCM machines**

TO MOUNT ON **IMA** EDGE BANDING MACHINES

D	S	S1	F	Z	Left Code	Right Code	€
70	20	12,5	20+2CH	6	■ T410M70206BL	■ T410M70206BR	183,00

Spec. T410M99L T410M99

● = Ready in stock ■ = Delivery time 20 working days △ = On request

SPARE PARTS

Type	Dimensions	Code	€
Reversible knife	20X12X1,5	● C020M20012AA	2,80
Clamping wedge	18X10X10	● ETASS18	10,00
Knife screw	M6X12	● WV029	1,00
"T" allen key	Esag.3	● ACHET03AAAAA	7,40

TO MOUNT ON **scm** EDGE BANDING MACHINES

D	S	S1	F	Z	Left Code	Right Code	€
70	20	12	16+2CH	4	■ T410M70204AL	■ T410M70204AR	146,20
70	30	12	16+2CH	4	■ T410M70304AL	■ T410M70304AR	175,40

Spec. T410M99L T410M99R

SPARE PARTS

Type	Dimensions	Code	€
Reversible knife	12X12X1,5	● C020M20012AA	2,80
Reversible knife	30X12X1,5	● C020M30012AB	3,40
Clamping wedge	18X10X10	● ETASS18	10,00
Clamping wedge	28X10X10	● ETASS28	10,80
Knife screw	M6X12	● WV029	1,00
"T" allen key	Esag. 3	● ACHET03AAAAA	7,40

NOTE

■ Utensili non a magazzino, quantità minima d'ordine: **2 pezzi**.
Tools not ready in stock minimum order quantity: **2 pieces**.

Il prezzo include coltelli e 1 chiave di regolazione.
The price included knives and 1 screwdriver.

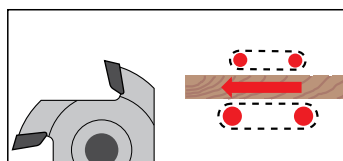
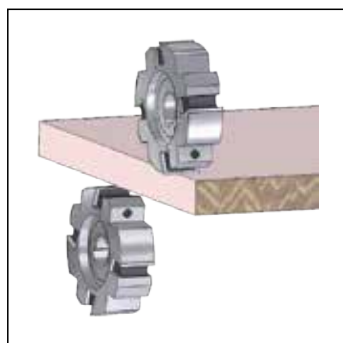
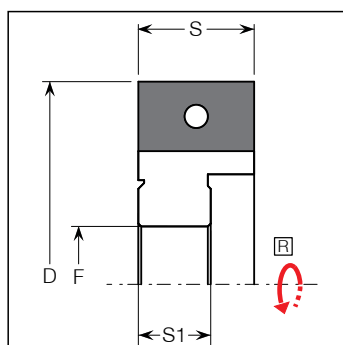

TAGLIO / SEZIONATURA
SAWING

DIAMANTE
DIAMOND

FRESATURA
CUTTING

PANTOGRAFATURA
ROUTING

FORATURA
BORING

MANDRINI / ATTACCHI
CHUCKS & CLAMPING SYSTEM

RICAMBI E LAVORAZIONI SUPP.
SPARE PARTS & ADD. WORKING

Teste portacoltelli a profilo diritto per bordatrici

Kanten-Füge-Messerköpfe

Porte outils d'affleurage droites

Фрезы радиусные для кромочных станков

T420

HW Edge banding cutterheads

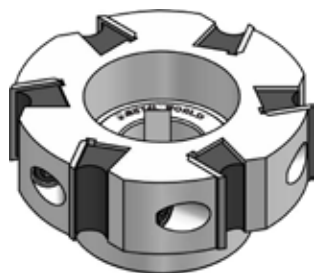
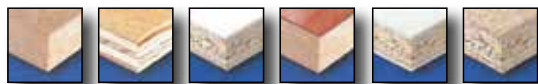

Costruite con corpo in acciaio bonificato • Coltelli in HW a fissaggio meccanico • Mozzo a sbalzo • Adatte per rifilare bordi ABS, melaminici, laminati, nobilitati, impiallacciati • **Da montare su macchine BIESSE e SCM**

Body in hardened and tempered steel • HW turnover knives • Straight profile • Overhang hub • Suitable for trimming ABS melamine, laminates, veneer edges • **To mount on BIESSE and SCM machines**

TAGLIO / SEZIONATURA
SAWING

DIAMANTE
DIAMOND

FRESATURA
CUTTING

PANTOGRAFATURA
ROUTING

FORATURA
BORING

MANDRINI / ATTACCHI
CHUCKS & CLAMPING SYSTEM

RICAMBI E LAVORAZIONI SUPP.
SPARE PARTS & ADD. WORKING

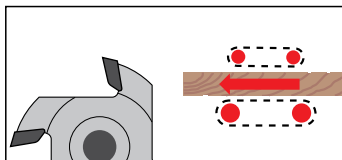
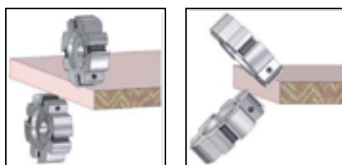
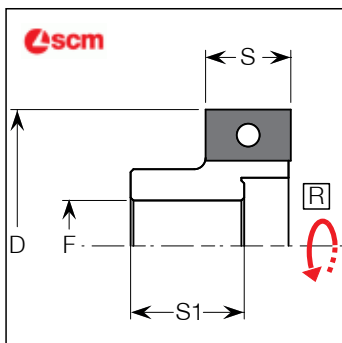
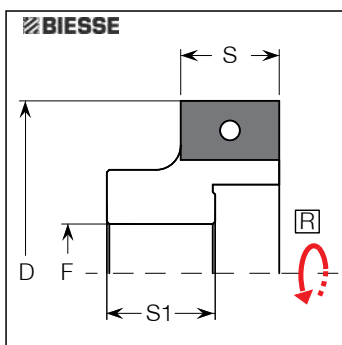

TO MOUNT ON BIESSE EDGE BANDING MACHINES

D	S	S1	F	Z	Left Code	Right Code	€
70	20	22	20+2CH	4	T420M70204AL	T420M70204AR	165,60
70	20	22	20+2CH	6	T420M70206AL	T420M70206AR	196,80
80	20	22	20+2CH	6	T420M80206AL	T420M80206AR	208,40

Spec. T420M99L T420M99R

● = Ready in stock ■ = Delivery time 20 working days ▲ = On request

SPARE PARTS

Type	Dimensions	Code	€
Reversible knife	20X12X1,5	● C020M20012AA	2,80
Clamping wedge	18X10X10	● ETASS18	10,00
Knife screw	M6X12	● WV029	1,00
"T" allen key	Esag.3	● ACHET03AAAAA	7,40

TO MOUNT ON SCM EDGE BANDING MACHINES

D	S	S1	F	Z	Left Code	Right Code	€
48	15	20	16+2CH	2	■ T420M48152AL	■ T420M48152AR	111,00
48	15	20	16+2CH	3	■ T420M48153AL	■ T420M48153AR	144,20

Spec. T420M99L T420M99R

SPARE PARTS

Type	Dimensions	Code	€
Reversible knife	15X9X1,5	● C016M14609AA	8,80
Knife screw	M3,5X4X7	● WV023	3,00
"T" allen key	Esag. 3	● ACHET03AAAAA	7,40

NOTE

■ Utensili non a magazzino, quantità minima d'ordine: **2 pezzi**.
Tools not ready in stock minimum order quantity: **2 pieces**.

Il prezzo include coltelli e 1 chiave di regolazione.
The price included knives and 1 screwdriver.

Teste portacoltelli a profilo inclinato per bordatrici

Kanten-Fase-Messerköpfe

Porte outils d'affleurage chanfrein

Фрезы для кромочных станков

T430

HW Edge chamfering cutterheads

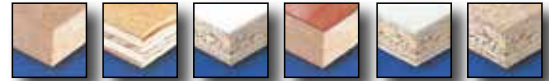
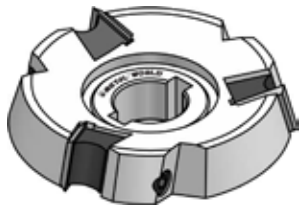

Costruite con corpo in acciaio bonificato • Coltelli in HW a fissaggio meccanico • Mozzo a sbalzo • Adatte per rifilare bordi melaminici, laminati, nobilitati, impiallacciati • **Da montare su macchine BIESSE e HOMAG**

Body in hardened and tempered steel • HW turnover knives • Overhang hub • Suitable for trimming melamine, laminates, veneer edges • **To mount on BIESSE and HOMAG machines**

TO MOUNT ON **BIESSE** EDGE BANDING MACHINES

D	S	S1	F	Z	β	Left Code	Right Code	€
73	12	19	16+2CH	6	25°	■ T430M73126AL	■ T430M73126AR	222,00

Spec. T430M99L T430M99R

● = Ready in stock ■ = Delivery time 20 working days △ = On request

SPARE PARTS

Type	Dimensions	Code	€
Reversible knife	12X12X1,5	● C020M12012AA	2,20
Clamping wedge	10X10X10	● ETASS10	8,10
Knife screw	M6X10	● WV035	1,0
"T" allen key	Esag.3	● ACHET03AAAAA	7,40

TO MOUNT ON HOMAG EDGE BANDING MACHINES

D	S	S1	F	Z	β	Left Code	Right Code	€
65	12	11	16+2CH	3	15°	■ T430M65123AL	■ T430M65123AR	150,00
77	12	23	HSK25	4	20°	■ T430M77124AL	■ T430M77124AR	175,40

Spec. T430M99L T430M99R

SPARE PARTS

Type	Dimensions	Code	€
Reversible knife	12X12X1,5	● C020M12012AA	2,20
Clamping wedge	10X10X10	● ETASS10	8,10
Knife screw	M6X10	● WV035	1,0
"T" allen key	Esag.3	● ACHET03AAAAA	7,40

NOTE

■ Utensili non a magazzino, quantità minima d'ordine: **2 pezzi**.
Tools not ready in stock minimum order quantity: **2 pieces**.

Il prezzo include coltelli e 1 chiave di regolazione.
The price included knives and 1 screwdriver.

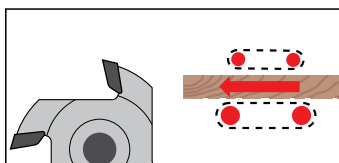
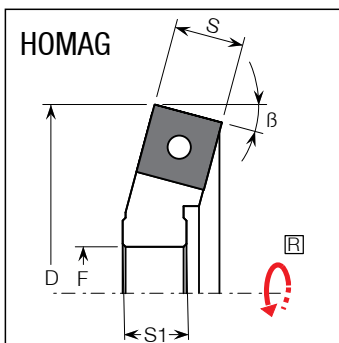
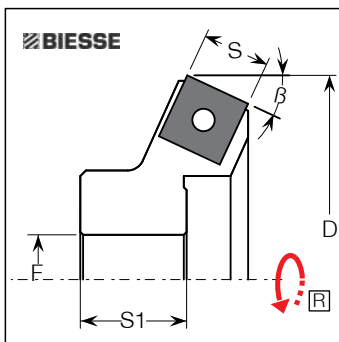

TAGLIO / SEZIONATURA
SAWING

DIAMANTE
DIAMOND

FRESATURA
CUTTING

PANTOGRAFATURA
ROUTING

FORATURA
BORING

MANDRINI / ATTACCHI
CHUCKS & CLAMPING SYSTEM

RICAMBI E LAVORAZIONI SUPP.
SPARE PARTS & ADD. WORKING

Teste portacoltelli a profilo inclinato per bordatrici

Kanten-Fase-Messerköpfe

Porte outils d'affleurage chanfrein

Фрезы радиусные для кромоочных станков

T430

HW Edge chamfering cutterheads

TAGLIO / SEZIONATURA
SAWING

DIAMANTE
DIAMOND

FRESATURA
CUTTING

PANTOGRAFATURA
ROUTING

FORATURA
BORING

MANDRINI / ATTACCHI
CHUCKS & CLAMPING SYSTEM

RICAMBI E LAVORAZIONI SUPP.
SPARE PARTS & ADD. WORKING

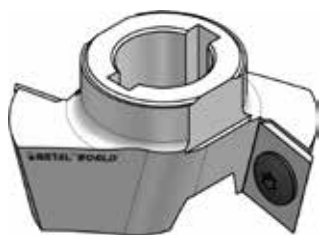
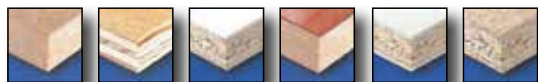

Costruite con corpo in acciaio bonificato • Coltelli in HW a fissaggio meccanico • Mozzo a sbalzo • Adatte per rifilare bordi melaminici, laminati, nobilitati, impiallacciati • **Da montare su macchine BIESSE e HOMAG**

Body in hardened and tempered steel • HW turnover knives • Overhang hub • Suitable for trimming melamine, laminates, veneer edges • **To mount on IMA and SCM machines**

TO MOUNT ON **IMA** EDGE BANDING MACHINES

D	S	S1	F	Z	β	Left Code	Right Code	€
77	12	23	HSK25	4	20°	■ T430M77124AL	■ T430M77124AR	175,40

Spec. T430M99L T430M99R

● = Ready in stock ■ = Delivery time 20 working days △ = On request

SPARE PARTS

Type	Dimensions	Code	€
Reversible knife	12X12X1,5	● C020M12012AA	2,20
Clamping wedge	10X10X10	● ETASS10	8,10
Knife screw	M6X10	● WV035	1,00
"T" allen key	Esag.3	● ACHET03AAAAA	7,40

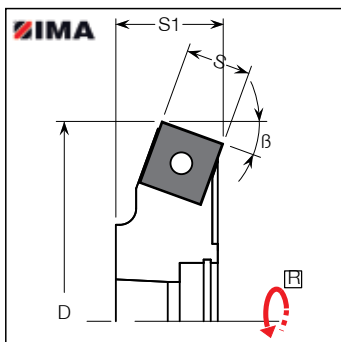

TO MOUNT ON **scm** EDGE BANDING MACHINES

D	S	S1	F	Z	β	Left Code	Right Code	€
53	15	20	16+2CH	2	12°	■ T430M53152AL	■ T430M53152AR	124,60

Spec. T430M99L T430M99R

SPARE PARTS

Type	Dimensions	Code	€
Reversible knife	15X12X1,5	● C020M15012AA	2,40
Screw	M4X6X9	● WV005	3,00
Torx key	Torx15	● ACHTC15AAAAA	11,80

NOTE

■ Utensili non a magazzino, quantità minima d'ordine: **2 pezzi.**
Tools not ready in stock minimum order quantity: **2 pieces.**

Il prezzo include coltelli e 1 chiave di regolazione.
The price included knives and 1 screwdriver.

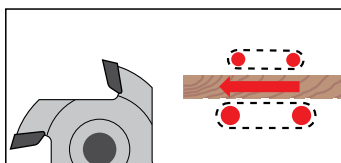
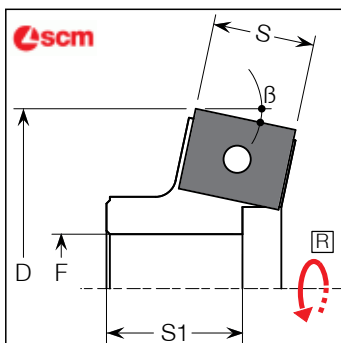

Teste portacoltelli
a profilo inclinato
per bordatrici

Kanten-Fase-
Messerköpfe

Porte outils d'affleurage
chanfrein

Фрезы для кромочных
станков

T435

HW Edge chamfering cutterheads

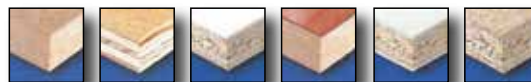

Costruite con corpo in acciaio bonificato • Coltelli in HW a fissaggio meccanico • Profilo inclinato • Mozzo centrale • Corpo simmetrico • Adatte per rifilare bordi melamminici, laminati, nobilitati, impiallacciati • **Da montare su macchine SCM**

Body in hardened and tempered steel • HW turnover knives • Chamfer profile • Central hub • Symmetrical body • Suitable for trimming melamine, laminates, veneer edges • **To mount on SCM machines**

TO MOUNT ON EDGE BANDING MACHINES

D	S	S1	F	Z	β	Code	€
64	16	12	16+2CH	4	20°	T435M64164AR	198,60
76	16	12	16+2CH	4	15°	T435M76164AR	198,60

Spec. T435M99

= Ready in stock = Delivery time 20 working days = On request

SPARE PARTS

Type	Dimensions	Code	€
Profiled knife 20°	16X13,7X2	WCS435M20AAA	20,60
Profiled knife 15°	16X13,7X2	WCS435M15AAA	20,60
Clamping wedge	13X10X10	ETASS435	18,00
Positioning knife	M4X7,5	WV002	3,00
Screw knife	M6X12	WV029	1,00
"T" allen key	Esag.3	ACHET03AAAAA	7,40

NOTE

Utensili non a magazzino, quantità minima d'ordine: **2 pezzi**.
Tools not ready in stock minimum order quantity: 2 pieces.

Il prezzo include coltelli e 1 chiave di regolazione.
The price included knives and 1 screwdriver.

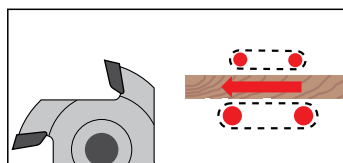
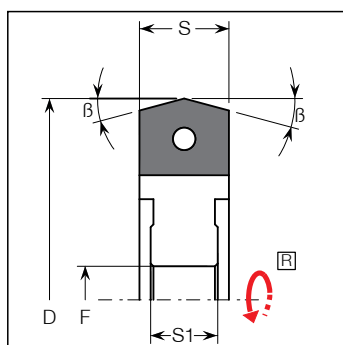

TAGLIO / SEZIONATURA
SAWING

DIAMANTE
DIAMOND

FRESATURA
CUTTING

PANTOGRAFATURA
ROUTING

FORATURA
BORING

MANDRINI / ATTACCHI
CHUCKS & CLAMPING SYSTEM

RICAMBI E LAVORAZIONI SUPP.
SPARE PARTS & ADD. WORKING

Teste portacoltelli sagomate a raggio per bordatrici

Kanten-Abrund Messerköpfe

Porte outils d'affleurage à arrondir

Фрезы мультирадиусные для кромоочных

T440

HW Edge profiling cutterheads

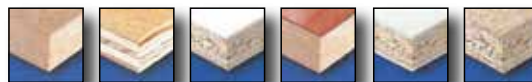

Costruite con corpo in acciaio bonificato • Coltelli in HW a fissaggio meccanico • Mozzo centrale • Corpo simmetrico
• Indicate per la raggatura di bordi in ABS di pannelli truciolari o MDF bimerlamini e/o bilaminati • Ottima qualità di finitura • **Da montare su macchine BIESSE e BRANDT**

Body in hardened and tempered steel • HW turnover knives • Central hub • Symmetrical body • Suitable for rounding ABS edges of MDF bilaminated or chipboard panels • Excellent finish quality • **To mount on BIESSE and BRANDT machines**

TO MOUNT ON **BIESSE** EDGE BANDING MACHINES

D	D1	S	S1	F	Z	R	Code	€
75	70	20	12	16+2CH	6	1	■ T440M75206AA	327,20
75	70	20	12	16+2CH	6	1,5	■ T440M75206BA	327,20
75	70	20	12	16+2CH	6	2	■ T440M75206CA	327,20

Spec.

T440M99

● = Ready in stock ■ = Delivery time 20 working days ▲ = On request

SPARE PARTS

Type	Dimensions	R	Code	€
Profiled knife	20X15,5X2	1	■ WCS440M10AAA	21,00
Profiled knife	20X15,5X2	1,5	■ WCS440M15AAA	21,00
Profiled knife	20X15,5X2	2	■ CS440M20AAA	21,00
Clamping wedge	16X10X10		■ ETASS440	16,20
Positioning screw	M4X7,5		● WV002	3,00
Knife screw	M6X12		● WV029	1,00
"T" allen key	Esag. 3		● ACHET03AAAAA	7,40

TO MOUNT ON BRANDT EDGE BANDING MACHINES

D	D1	S	S1	F	Z	R	Code	€
78	70	16	11	16+2CH	4	1	■ T440M78164DD	274,60
78	70	16	11	16+2CH	4	1,5	■ T440M78164BA	274,60
78	70	16	11	16+2CH	4	2	■ T440M78164CA	274,60
78	70	16	11	16+2CH	4	3	■ T440M78164DA	274,60
78	70	16	11	16+2CH	6	1	■ T440M78166AA	336,80
78	70	16	11	16+2CH	6	1,5	■ T440M78166BA	336,80
78	70	16	11	16+2CH	6	2	■ T440M78166CA	336,80
78	70	16	11	16+2CH	6	3	■ T440M78166DA	336,80

Spec.

T440M99

SPARE PARTS

Type	Dimensions	R	Code	€
Profiled knife	16X17,5X2	1	■ WCS440MB10AA	21,00
Profiled knife	16X17,5X2	1,5	■ WCS440MB15AA	21,00
Profiled knife	16X17,5X2	2	■ WCS440MB20AA	21,00
Profiled knife	16X17,5X2	3	■ WCS440MB30AA	21,00
Clamping wedge for Z=4	13X10X10		■ ETASS440C	16,20
Clamping wedge for Z=6	13X10X10		■ ETASS440B	16,20
Positioning screw	M4X7,5		● WV002	3,00
Knife screw	M6X12		● WV029	1,00
"T" allen key	Esag. 3		● ACHET03AAAAA	7,40

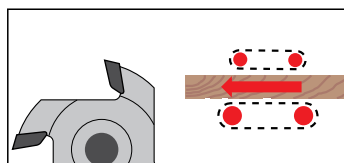
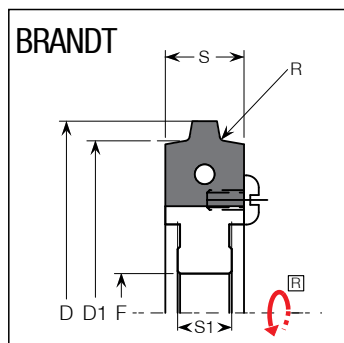
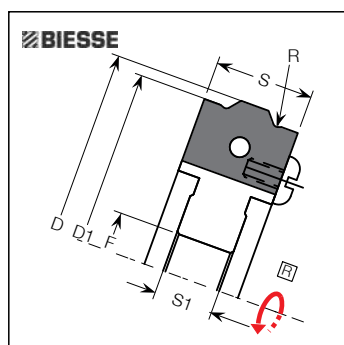

NOTE

■ Utensili non a magazzino, quantità minima d'ordine: **2 pezzi**.
Tools not ready in stock minimum order quantity: **2 pieces**.

Il prezzo include coltelli e 1 chiave di regolazione.

The price included knives and 1 screwdriver.

TAGLIO / SEZIONATURA
SAWING

DIAMANTE
DIAMOND

FRESATURA
CUTTING

PANTOGRAFATURA
ROUTING

FORATURA
BORING

MANDRINI / ATTACCHI
CHUCKS & CLAMPING SYSTEM

RICAMBI E LAVORAZIONI SUPP.
SPARE PARTS & ADD. WORKING

Teste portacoltelli sagomate a raggio per bordatrici

Kanten-Abrund Messerköpfe

Porte outils d'affleurage à arrondir

Фрезы радиусные для кромочных станков

T440

HW Edge profiling cutterheads

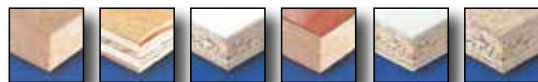

Costruite con corpo in acciaio bonificato • Coltelli in HW a fissaggio meccanico • Mozzo centrale • Corpo simmetrico
• Indicate per la raggatura di bordi in ABS di pannelli truciolari o MDF bimalaminici e/o bilaminati • Ottima qualità di finitura • **Da montare su macchine HOMAG e IMA**

Body in hardened and tempered steel • HW turnover knives • Central hub • Symmetrical body • Suitable for rounding ABS edges of MDF bilaminated or chipboard panels • Excellent finish quality • **To mount on HOMAG and IMA machines**

TO MOUNT ON HOMAG EDGE BANDING MACHINES

D	D1	S	S1	F	Z	R	Code	€
73	61	16	11	16+2CH	3	1	■ T440M73163AA	233,80
73	61	16	11	16+2CH	3	1,5	■ T440M73163BA	233,80
73	61	16	11	16+2CH	3	2	■ T440M73163CA	233,80
73	61	16	11	16+2CH	3	3	■ T440M73163DA	233,80
73	61	16	11	16+2CH	4	1	■ T440M73164AA	270,60
73	61	16	11	16+2CH	4	1,5	■ T440M73164BA	270,60
73	61	16	11	16+2CH	4	2	■ T440M73164CA	270,60
73	61	16	11	16+2CH	4	3	■ T440M73164DA	270,60

Spec. T440M99

SPARE PARTS

● = Ready in stock ■ = Delivery time 20 working days △ = On request

Type	Dimensions	R	Code	€
Profiled knife	16X19,5X2	1	■ WCS440MA10AA	21,00
Profiled knife	16X19,5X2	1,5	■ WCS440MA15AA	21,00
Profiled knife	16X19,5X2	2	■ WCS440MA20AA	21,00
Profiled knife	16X19,5X2	3	■ WCS440MA30AA	21,00
Clamping wedge	10X13X10		■ ETASS13	10,80
Positioning screw	M4X7,5	●	WV002	3,00
Knife screw	M6X12	●	WV029	1,00
"T" allen key	Esag.3	●	ACHET03AAAAA	7,40

TO MOUNT ON IMA EDGE BANDING MACHINES

D	D1	S	S1	F	Z	R	Code	€
78	70	16	11	20+2CH	4	1	■ T440M78164AA	274,60
78	70	16	11	20+2CH	4	1,5	■ T440M78164BC	274,60
78	70	16	11	20+2CH	4	2	■ T440M78164CD	274,60
78	70	16	11	20+2CH	4	3	■ T440M78164DC	274,60
78	70	16	11	20+2CH	6	1	■ T440M78166AC	336,80
78	70	16	11	20+2CH	6	1,5	■ T440M78166BC	336,80
78	70	16	11	20+2CH	6	2	■ T440M78166CC	336,80
78	70	16	11	20+2CH	6	3	■ T440M78166DB	336,80

Spec. T440M99

SPARE PARTS

Type	Dimensions	R	Code	€
Profiled knife	16X17,5X2	1	■ WCS440MB10AA	21,00
Profiled knife	16X17,5X2	1,5	■ WCS440MB15AA	21,00
Profiled knife	16X17,5X2	2	■ WCS440MB20AA	21,00
Profiled knife	16X17,5X2	3	■ WCS440MB30AA	21,00
Clamping wedge for Z=4	13X10X10		■ ETASS440C	16,20
Clamping wedge for Z=6	13X10X10		■ ETASS440B	16,20
Positioning screw	M4X7,5	●	WV002	3,00
Knife screw	M6X12	●	WV029	1,00
"T" allen key	Esag. 3	●	ACHET03AAAAA	7,40

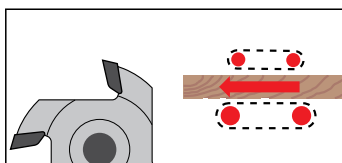
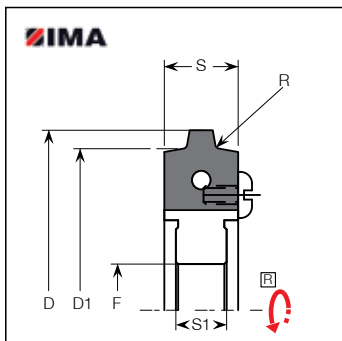
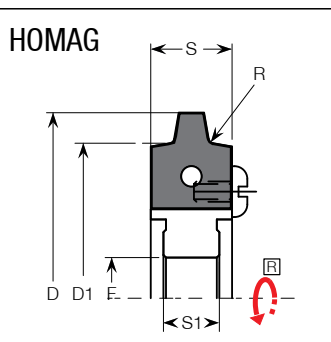

NOTE

■ Utensili non a magazzino, quantità minima d'ordine: **2 pezzi**.
Tools not ready in stock minimum order quantity: **2 pieces**.

Il prezzo include coltelli e 1 chiave di regolazione.
The price included knives and 1 screwdriver.

TAGLIO / SEZIONATURA
SAWING

DIAMANTE
DIAMOND

FRESATURA
CUTTING

PANTOGRAFATURA
ROUTING

FORATURA
BORING

MANDRINI / ATTACCHI
CHUCKS & CLAMPING SYSTEM

RICAMBI E LAVORAZIONI SUPP.
SPARE PARTS & ADD. WORKING

Teste portacoltelli sagomate a raggio per bordatrici

Kanten-Abrund Messerköpfe

Porte outils d'affleurance à arrondir

Фрезы мультирадиусные для кромочных

T440

HW Edge profiling cutterheads

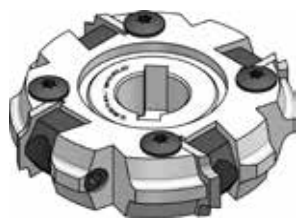
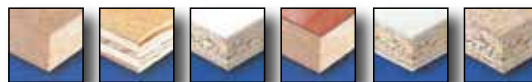

Costruite con corpo in acciaio bonificato • Coltelli in HW a fissaggio meccanico • Mozzo centrale • Corpo simmetrico • Indicate per la raggatura di bordi in ABS di pannelli truciolari o MDF bimalaminici e/o bilaminati • Ottima qualità di finitura • **Da montare su macchine SCM**

Body in hardened and tempered steel • HW turnover knives • Central hub • Symmetrical body • Suitable for rounding ABS edges of MDF bilaminated or chipboard panels • Excellent finish quality • **To mount on SCM machines**

TAGLIO / SEZIONATURA
SAWING

DIAMANTE
DIAMOND

FRESATURA
CUTTING

PANTOGRAFATURA
ROUTING

FORATURA
BORING

MANDRINI / ATTACCHI
CHUCKS & CLAMPING SYSTEM

RICAMBI E LAVORAZIONI SUPP.
SPARE PARTS & ADD. WORKING

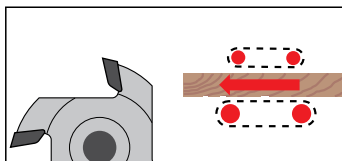
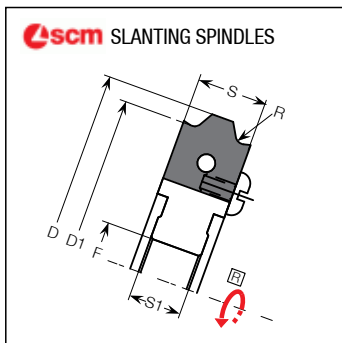
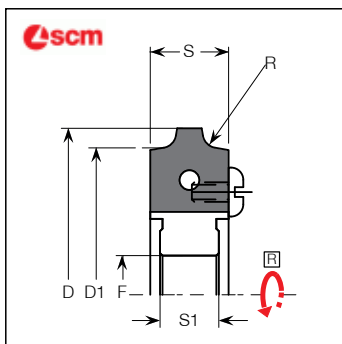

NOTE
■ Utensili non a magazzino, quantità minima d'ordine: **2 pezzi**.
Tools not ready in stock minimum order quantity: **2 pieces**.

Il prezzo include coltelli e 1 chiave di regolazione.
The price included knives and 1 screwdriver.

TO MOUNT ON **scm** EDGE BANDING MACHINES

D	D1	S	S1	F	Z	R	Code	€
66	60	16	12	16+2CH	4	1	■ T440M66164AA	270,60
66	60	16	12	16+2CH	4	1,5	■ T440M66164BA	270,60
66	60	16	12	16+2CH	4	2	■ T440M66164CA	270,60
68	60	16	12	16+2CH	4	3	■ T440M68164DA	270,60

Spec. T440M99

● = Ready in stock ■ = Delivery time 20 working days ▲ = On request

SPARE PARTS

Type	Dimensions	R	Code	€
Profiled knife	16X16,5X2	1	■ WCS440MC10AA	21,00
Profiled knife	16X16,5X2	1,5	■ WCS440MC15AA	21,00
Profiled knife	16X16,5X2	2	■ WCS440MC20AA	21,00
Profiled knife	16X16,5X2	3	■ WCS440MC30AA	21,00
Clamping wedge	13X10X10		■ ETASS13	10,80
Positioning screw	M4X7,5		● WV002	3,00
Knife screw	M6X12		● WV029	1,00
"T" allen key	Esag. 3		● ACHET03AAAAA	7,40

TO MOUNT ON **scm** EDGE BANDING MACHINES SLANTING SPINDLES

D	D1	S	S1	F	Z	R	Code	€
78	70	16	11	16+2CH	4	1	■ T440M78164AB	270,60
78	70	16	11	16+2CH	4	1,5	■ T440M78164BB	270,60
78	70	16	11	16+2CH	4	2	■ T440M78164CB	270,60
78	70	16	12	16+2CH	4	2	■ T440M78164CC	270,60
78	70	16	11	16+2CH	6	1	■ T440M78166AB	327,20
78	70	16	11	16+2CH	6	1,5	■ T440M78166BB	327,20
78	70	16	11	16+2CH	6	2	■ T440M78166CB	327,20

Spec. T440M99

SPARE PARTS

Type	Dimensions	R	Code	€
Profiled knife	16X14,4X2	1	■ WCS440MD10AA	21,00
Profiled knife	16X14,4X2	1,5	■ WCS440MD15AA	21,00
Profiled knife	16X14,4X2	2	■ WCS440MD20AA	21,00
Clamping wedge for Z=4	13X10X10		■ ETASS440C	16,20
Clamping wedge for Z=6	13X10X10		■ ETASS440D	16,20
Positioning screw	M4X6X9		● WV005	3,00
Knife screw	M6X10		● WV035	1,00
"T" allen key	Esag. 3		● ACHET03AAAAA	7,40

Teste portacoltelli sagomate a raggio per bordatrici

Kanten-Abrund Messerköpfe

Porte outils d'affleurance à arrondir

Фрезы радиусные для кромочных станков

T441

HW Edge profiling cutterheads

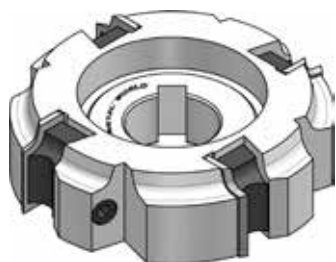
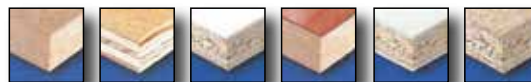

Costruite con corpo in acciaio bonificato • Coltelli in HW a fissaggio meccanico • Mozzo laterale • Indicate per la raggiatura di bordi in ABS di pannelli truciolari o MDF bimerlamini e/o bilaminati • **Da montare su macchine IMA e SCM**

Body in hardened and tempered steel • HW turnover knives • Lateral hub • Suitable for rounding ABS edges of MDF bilaminated or chipboard panels • **To mount on IMA and SCM machines**

TO MOUNT ON **IMA** EDGE BANDING MACHINES

D	D1	S	S1	F	Z	R	Left Code	Right Code	€
70	62	20	12,5	20+2CH	4	1	■ T441M70204AL	■ T441M70204AR	255,20
70	62	20	12,5	20+2CH	4	1,5	■ T441M70204BL	■ T441M70204BR	255,20
70	62	20	12,5	20+2CH	4	2	■ T441M70204CL	■ T441M70204CR	255,20

Spec. T441M99L T441M99R

● = Ready in stock ■ = Delivery time 20 working days △ = On request

SPARE PARTS

Type	Dimensions	R	Left Code	Right Code	€
Profiled knife	20X12X1,5	1	■ WCS441ML10AA	■ WCS441MR10AA	18,00
Profiled knife	20X12X1,5	1,5	■ WCS441ML15AA	■ WCS441MR15AA	18,00
Profiled knife	20X12X1,5	2	■ WCS441ML20AA	■ WCS441MR20AA	18,00
Clamping wedge	16X10X10		■ ETASS441L	■ ETASS441R	16,20
Positioning screw	M4X7,5	●		● WV002	3,00
Knife screw	M6X10	●		● WV035	1,00
"T" allen key	Esag. 3	●		● ACHET03AAAAA	7,40

TO MOUNT ON **scm** EDGE BANDING MACHINES SLANTING SPINDLES

D	D1	S	S1	F	Z	R	Left Code	Right Code	€
75	70	20	12	16+2CH	4	1	■ T441M75204AL	■ T441M75204AR	261,00
75	70	20	12	16+2CH	4	1,5	■ T441M75204BL	■ T441M75204BR	261,00
75	70	20	12	16+2CH	4	2	■ T441M75204CL	■ T441M75204CR	261,00

Spec. T441M99L T441M99R

SPARE PARTS

Type	Dimensions	R	Left Code	Right Code	€
Profiled knife	20X12X1,5	1	■ WCS441ML10AA	■ WCS441MR10AA	18,00
Profiled knife	20X12X1,5	1,5	■ WCS441ML15AA	■ WCS441MR15AA	18,00
Profiled knife	20X12X1,5	2	■ WCS441ML20AA	■ WCS441MR20AA	18,00
Clamping wedge	16X10X10		■ ETASS441L	■ ETASS441R	16,20
Positioning screw	M4X7,5	●		● WV002	3,00
Knife screw	M6X12	●		● WV029	1,00
"T" allen key	Esag. 3	●		● ACHET03AAAAA	7,40

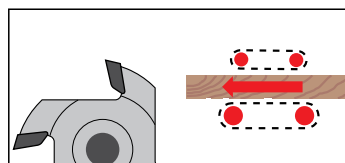
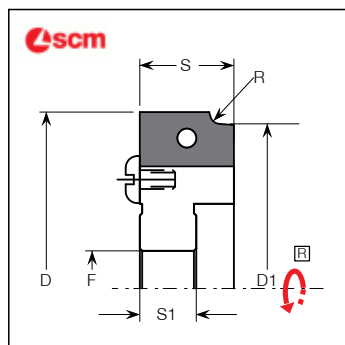
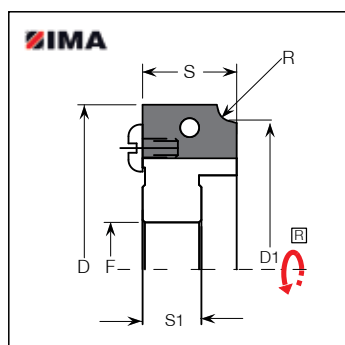

NOTE

■ Utensili non a magazzino, quantità minima d'ordine: **2 pezzi**.
Tools not ready in stock minimum order quantity: **2 pieces**.

Il prezzo include coltelli e 1 chiave di regolazione.
The price included knives and 1 screwdriver.

TAGLIO / SEZIONATURA
SAWING

DIAMANTE
DIAMOND

FRESATURA
CUTTING

PANTOGRAFATURA
ROUTING

FORATURA
BORING

MANDRINI / ATTACCHI
CHUCKS & CLAMPING SYSTEM

RICAMBI E LAVORAZIONI SUPP.
SPARE PARTS & ADD. WORKING

Teste portacoltelli sagomate a raggio per bordatrici

Kanten-Abrund Messerköpfe

Porte outils d'affleurage à arrondir

Фрезы радиусные для кромоочных станков

T442

HW Edge profiling cutterheads

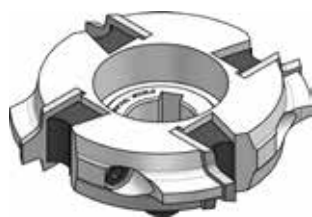

Costruite con corpo in acciaio bonificato • Coltelli in HW a fissaggio meccanico • Mozzo a sbalzo • Indicate per la raggiatura di bordi in ABS di pannelli truciolari o MDF bimalaminici e/o bilaminati • **Da montare su macchine BIESSE**

Body in hardened and tempered steel • HW turnover knives • Overhang hub • Suitable for rounding ABS edges of MDF bilaminated or chipboard panels • **To mount on BIESSE machines**

TAGLIO / SEZIONATURA
SAWING

DIAMANTE
DIAMOND

FRESATURA
CUTTING

PANTOGRAFATURA
ROUTING

FORATURA
BORING

MANDRINI / ATTACCHI
CHUCKS & CLAMPING SYSTEM

RICAMBI E LAVORAZIONI SUPP.
SPARE PARTS & ADD. WORKING

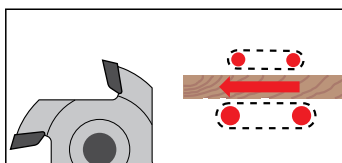
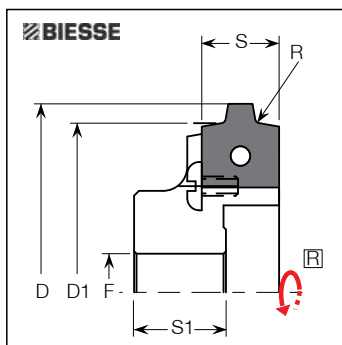
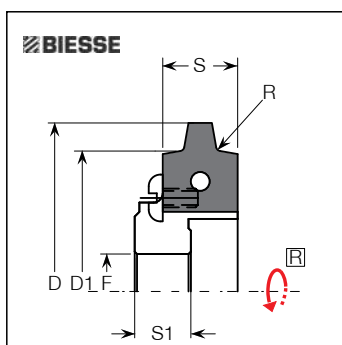

NOTE
 ■ Utensili non a magazzino, quantità minima d'ordine: **2 pezzi**.
 Tools not ready in stock minimum order quantity: **2 pieces**.

Il prezzo include coltelli e 1 chiave di regolazione.
 The price included knives and 1 screwdriver.

TO MOUNT ON **BIESSE** EDGE BANDING MACHINES

D	D1	S	S1	F	Z	R	Left Code	Right Code	€
72	60	16	12	16+2CH	4	1	■ T442M72164AL	■ T442M72164AR	280,40
72	60	16	12	16+2CH	4	1,5	■ T442M72164BL	■ T442M72164BR	280,40
72	60	16	12	16+2CH	4	2	■ T442M72164CL	■ T442M72164CR	280,40
72	60	16	12	16+2CH	4	3	■ T442M72164DL	■ T442M72164DR	280,40

Spec.							T442M99L	T442M99R	
-------	--	--	--	--	--	--	----------	----------	--

● = Ready in stock ■ = Delivery time 20 working days ▲ = On request

SPARE PARTS

Type	Dimensions	R	Code	€
Profiled knife	16X19,5X2	1	■ WCS440MA10AA	21,00
Profiled knife	16X19,5X2	1,5	■ WCS440MA15AA	21,00
Profiled knife	16X19,5X2	2	■ WCS440MA20AA	21,00
Profiled knife	16X19,5X2	3	■ WCS440MA30AA	21,00
Clamping wedge	13X10X10		■ ETASS13	10,80
Positioning screw	M4X7,5		● WV002	3,00
Knife screw	M6X12		● WV029	1,00
"T" allen key	Esag. 3		● ACHET03AAAAA	7,40

TO MOUNT ON **BIESSE** EDGE BANDING MACHINES

D	D1	S	S1	F	Z	R	Left Code	Right Code	€
78	70	16	19	16+2CH	4	1	■ T442M78164AL	■ T442M78164AR	288,20
78	70	16	19	16+2CH	4	1,5	■ T442M78164BL	■ T442M78164BR	288,20
78	70	16	19	16+2CH	4	2	■ T442M78164CL	■ T442M78164CR	288,20
78	70	16	19	16+2CH	4	3	■ T442M78164DL	■ T442M78164DR	288,20
78	70	16	19	16+2CH	6	1	■ T442M78166AL	■ T442M78166AR	348,60
78	70	16	19	16+2CH	6	1,5	■ T442M78166BL	■ T442M78166BR	348,60
78	70	16	19	16+2CH	6	2	■ T442M78166CL	■ T442M78166CR	348,60
78	70	16	19	16+2CH	6	3	■ T442M78166DL	■ T442M78166DR	348,60

Spec.							T442M99L	T442M99R	
-------	--	--	--	--	--	--	----------	----------	--

SPARE PARTS

Type	Dimensions	R	Code	€
Profiled knife	16X17,5X2	1	■ WCS440MB10AA	21,00
Profiled knife	16X17,5X2	1,5	■ WCS440MB15AA	21,00
Profiled knife	16X17,5X2	2	■ WCS440MB20AA	21,00
Profiled knife	16X17,5X2	3	■ WCS440MB30AA	21,00
Clamping wedge for Z=4	13X10X10		■ ETASS440C	16,20
Clamping wedge for Z=6	13X10X10		■ ETASS440B	16,20
Positioning screw	M4X7,5		● WV002	3,00
Knife screw	M6X12		● WV029	1,00
"T" allen key	Esag. 3		● ACHET03AAAAA	7,40

Teste portacoltelli sagomate a raggio per bordatrici

Kanten-Abrund Messerköpfe

Porte outils d'affleurement à arrondir

Фрезы радиусные для кромочных станков

T442

HW Edge profiling cutterheads



Costruite con corpo in acciaio bonificato • Coltelli in HW a fissaggio meccanico • Mozzo a sbalzo • Indicate per la raggiatura di bordi in ABS di pannelli truciolari o MDF bimerlamini e/o bilaminati • **Da montare su macchine HOMAG, IMA, SCM**

Body in hardened and tempered steel • HW turnover knives • Overhang hub • Suitable for rounding ABS edges of MDF bilaminated or chipboard panels • **To mount on HOMAG, IMA and SCM machines**

TO MOUNT ON AND **IMA** EDGE BANDING MACHINES

D	D1	S	S1	F	Z	R	Left Code	Right Code	€
78	70	16	23	HSK25	4	2	■ T442M78164EL	■ T442M78164ER	317,40
78	70	16	23	HSK25	4	3	■ T442M78164FL	■ T442M78164FR	317,40

Spec.	T442M99L	T442M99R
	● = Ready in stock	■ = Delivery time 20 working days

SPARE PARTS

Type	Dimensions	R	Code	€
Profiled knife	16X17,5X2	2	■ CS442MB20AA	21,00
Profiled knife	16X17,5X2	3	■ CS442MB30AA	21,00
Clamping wedge	13X10X10		■ ETASS13	10,80
Positioning screw	M4X7,5	●	WV002	3,00
Knife screw	M6X12	●	WV029	1,00
"T" allen key	Esag. 3	●	ACHET03AAAAA	7,40

TO MOUNT ON **scm** EDGE BANDING MACHINES

D	D1	S	S1	F	Z	R	Left Code	Right Code	€
56	48	15	20	16+2CH	2	1	■ T442M56152AL	■ T442M56152AR	159,80
56	48	15	20	16+2CH	2	1,5	■ T442M56152BL	■ T442M56152BR	159,80
56	48	15	20	16+2CH	2	2	■ T442M56152CL	■ T442M56152CR	159,80
56	48	15	20	16+2CH	2	3	■ T442M56152DL	■ T442M56152DR	159,80
56	48	15	20	16+2CH	3	1	■ T442M56153AL	■ T442M56153AR	208,40
56	48	15	20	16+2CH	3	1,5	■ T442M56153BL	■ T442M56153BR	208,40
56	48	15	20	16+2CH	3	2	■ T442M56153CL	■ T442M56153CR	208,40
56	48	15	20	16+2CH	3	3	■ T442M56153DL	■ T442M56153DR	208,40

Spec.	T442M99L	T442M99R
	● = Ready in stock	■ = Delivery time 20 working days

SPARE PARTS

Type	Dimensions	R	Left Code	Right Code	€
Profiled knife	15X12X1,5	1	■ CS442ML10AA	■ CS442MR10AA	18,00
Profiled knife	15X12X1,5	1,5	■ CS442ML15AA	■ CS442MR15AA	18,00
Profiled knife	15X12X1,5	2	■ CS442ML20AA	■ CS442MR20AA	18,00
Profiled knife	15X12X1,5	3	■ CS442ML30AA	■ CS442MR30AA	18,00
Clamping wedge	13X10X10		■ ETASS442L	■ ETASS442R	16,20
Positioning screw	M4X7,5	●	WV002	WV002	3,00
Knife screw	M6X10	●	WV035	WV035	1,00
"T" allen key	Esag. 3	●	ACHET03AAAAA	ACHET03AAAAA	7,40

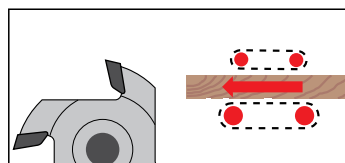
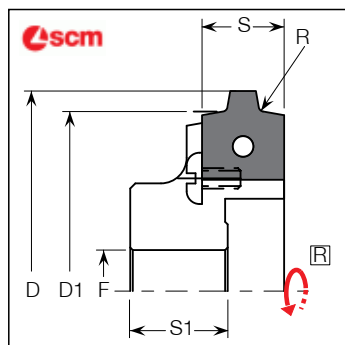
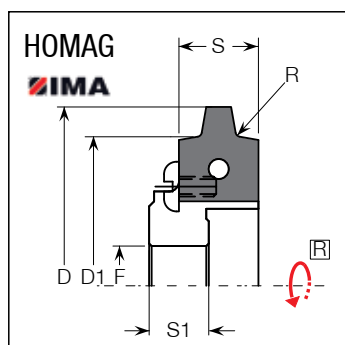

NOTE

■ Utensili non a magazzino, quantità minima d'ordine: **2 pezzi**.
Tools not ready in stock minimum order quantity: **2 pieces**.

Il prezzo include coltelli e 1 chiave di regolazione.
The price included knives and 1 screwdriver.

TAGLIO / SEZIONATURA
SAWING

DIAMANTE
DIAMOND

FRESATURA
CUTTING

PANTOGRAFATURA
ROUTING

FORATURA
BORING

MANDRINI / ATTACCHI
CHUCKS & CLAMPING SYSTEM

RICAMBI E LAVORAZIONI SUPP.
SPARE PARTS & ADD. WORKING

Teste portacoltelli sagomate a raggio per bordatrici

Kanten-Abrund Messerköpfe

Porte outils d'affleurance à arrondir

Фрезы мультирадиусные для кромочных

T446

HW Edge profiling cutterheads

TAGLIO / SEZIONATURA
SAWING

DIAMANTE
DIAMOND

FRESATURA
CUTTING

PANTOGRAFATURA
ROUTING

FORATURA
BORING

MANDRINI / ATTACCHI
CHUCKS & CLAMPING SYSTEM

RICAMBI E LAVORAZIONI SUPP.
SPARE PARTS & ADD. WORKING

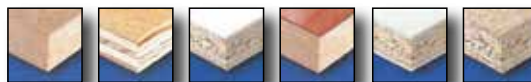

Costruite con corpo in acciaio bonificato • Coltelli in HW a fissaggio meccanico • Mozzo a sbalzo • Indicate per la raggiatura di bordi in ABS di pannelli truciolari o MDF bimerlamini e/o bilaminati • **Da montare su macchine IMA**

Body in hardened and tempered steel • HW turnover knives • Overhang hub • Suitable for rounding ABS edges of MDF bilaminated or chipboard panels • **To mount on IMA machines**

TO MOUNT ON **IMA** EDGE BANDING MACHINES

D	D1	S	S1	F	Z	R	Left Code	Right Code	€
77	70	13	13	20	4	2	■ T446M70134AL	■ T446M70134AR	298,00
77	70	13	13	20	4	3	■ T446M70134BL	■ T446M70134BR	327,20
77	70	13	13	20	4	4	■ T446M70134CL	■ T446M70134CR	327,20

Spec.

T446M99L

T446M99R

● = Ready in stock ■ = Delivery time 20 working days △ = On request

SPARE PARTS

Type	Dimensions	R	Code	€
Reversible knife	13X16X2	1	■ SC265M021316	21,00
Reversible knife	13X16X2	1,5	■ SC265M031316	21,00
Reversible knife	13X16X2	2	■ SC265M041316	21,00
Clamping wedge	12X13X10		■ ETASS121310P	21,00
Ogive cl. system	10X11,5XM6SX		● WOG04	2,00
Screw	M6X18		● WV033	3,00
"T" allen key	Esag. 3		● ACHET03AAAAA	7,40

NOTE

■ Utensili non a magazzino, quantità minima d'ordine: **2 pezzi.**
Tools not ready in stock minimum order quantity: **2 pieces.**

Il prezzo include coltelli e 1 chiave di regolazione.
The price included knives and 1 screwdriver.

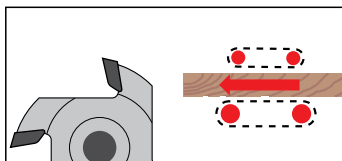
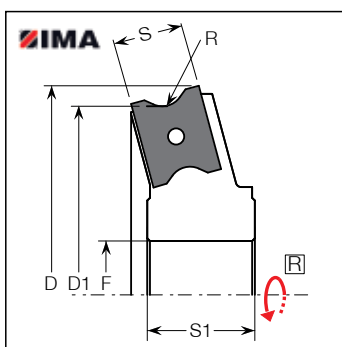

Teste portacoltelli sagomate a raggio per bordatrici

Kanten-Abrund Messerköpfe

Porte outils d'affleurement à arrondir

Фрезы радиусные для кромочных станков

T450

HW Edge profiling cutterheads

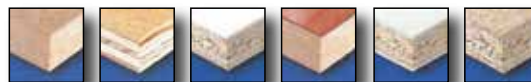

Costruite con corpo in acciaio bonificato • Coltelli in HW a fissaggio meccanico • Mozzo a sbalzo • Indicate per la raggiatura di bordi in ABS di pannelli truciolari o MDF bimalaminici e/o bilaminati • **Da montare su macchine BIESSE**

Body in hardened and tempered steel • HW turnover knives • Overhang hub • Suitable for rounding ABS edges of MDF bilaminated or chipboard panels • **To mount on BIESSE machines**

TO MOUNT ON **BIESSE** EDGE BANDING MACHINES

D	D1	S	S1	F	Z	R	Left Code	Right Code	€
74	70	16	21	20+2CH	6	2	■ T450M74166AL	■ T450M74166AR	305,80

Spec.

T450M99L

T450M99L

● = Ready in stock ■ = Delivery time 20 working days △ = On request

SPARE PARTS

Type	Dimensions	R	Left Code	Right Code	€
Profiled knife	16X14,5X2	2	■ WCS450ML20AA	■ WCS450MR20AA	21,00
Clamping wedge	15X10X10		■ ETASS450	■ ETASS450	16,20
Knife screw	M6X12	●		● WV029	1,00
Position screw	M4X7,5	●		● WV002	3,00
"T" allen key	Esag. 3	●		● ACHET03AAAAA	7,40

NOTE

■ Utensili non a magazzino, quantità minima d'ordine: **2 pezzi**.
Tools not ready in stock minimum order quantity: **2 pieces**.

Il prezzo include coltelli e 1 chiave di regolazione.
The price included knives and 1 screwdriver.

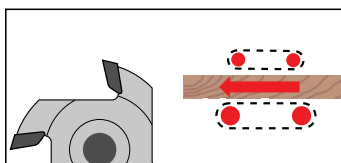
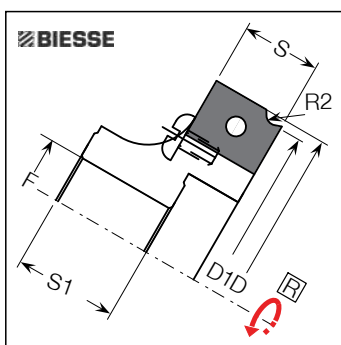

TAGLIO / SEZIONATURA
SAWING

DIAMANTE
DIAMOND

FRESATURA
CUTTING

PANTOGRAFATURA
ROUTING

FORATURA
BORING

MANDRINI / ATTACCHI
CHUCKS & CLAMPING SYSTEM

RICAMBI E LAVORAZIONI SUPP.
SPARE PARTS & ADD. WORKING

Teste portacoltelli sagomate multiraggio per bordatrici

Multiprofil Kanten-Messerköpfe

Porte outils d'affleutage multiprofiles

Фрезы мультирадиусные для кромочных

T480

HW Edge profiling cutterheads

TAGLIO / SEZIONATURA
SAWING

DIAMANTE
DIAMOND

FRESATURA
CUTTING

PANTOGRAFATURA
ROUTING

FORATURA
BORING

MANDRINI / ATTACCHI
CHUCKS & CLAMPING SYSTEM

RICAMBI E LAVORAZIONI SUPP.
SPARE PARTS & ADD. WORKING

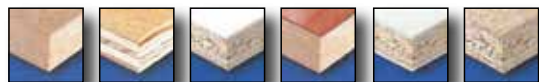

Costruite con corpo in acciaio bonificato • Coltelli in HW a fissaggio meccanico • Mozzo laterale • Indicate per la raggiatura di bordi in ABS di pannelli truciolari o MDF bime laminici e/o bilaminati • Da montare su macchine BIESSE • Su richiesta sono fornibili coltelli con altre combinazioni di raggi

Body in hardened and tempered steel • HW turnover knives • Lateral hub • Suitable for rounding ABS edges of MDF bilaminated or chipboard panels • To mount on BIESSE machines • On request the knives are supplied with different combination of radius

TO MOUNT ON **BIESSE** EDGE BANDING MACHINES

D	D1	S	S1	F	Z	Left Code	Right Code	€
75	60	25	15	16+2CH	4	■ T480M75254AL	■ T480M75254BL	311,60

Spec. T480M99L T480M99R

● = Ready in stock ■ = Delivery time 20 working days ▲ = On request

SPARE PARTS

Type	Dimensions	Left Code	Right Code	€
Profiled knife	25X18,5X2	■ WCS480MLAAAA	■ WCS480MRAAAA	28,00
Clamping wedge	21X10X10	■ ETASS480L	■ ETASS480R	19,80
Knife screw	M6X12	●	● WV029	1,00
Position screw	M4X7,5	●	● WV002	3,00
"T" allen key	Esag. 3	●	● ACHET03AAAAA	7,40

NOTE

■ Utensili non a magazzino, quantità minima d'ordine: **2 pezzi**.
Tools not ready in stock minimum order quantity: **2 pieces**.

Il prezzo include coltelli e 1 chiave di regolazione.
The price included knives and 1 screwdriver.

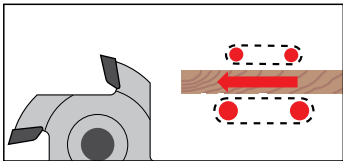
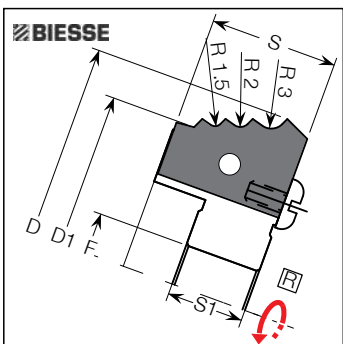



T490

HW Scraper holders

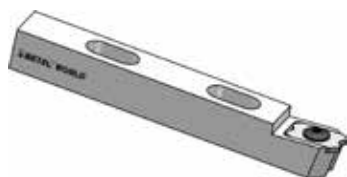

Costruiti con corpo in acciaio bonificato • Coltelli in HW a fissaggio meccanico • Da montare su macchine bordatrici • Adatti per rifinire il profilo raggato ABS

Body in hardened and tempered steel • HW turnover knives • To mount on edge banding machines • Suitable for finishing ABS edges with radius profile

TO MOUNT ON HOMAG EDGE BANDING MACHINES

Dimensions	F	Z	Code	€
131X16X15	16X15	1	■ T490M1311615	155,80

Spec. T490M99

● = Ready in stock ■ = Delivery time 20 working days △ = On request

SPARE PARTS

Type	Dimensions	R	Code	€
Revers.profiled knife	12X20X2	1	■ CS490M10AAA	31,00
Revers.profiled knife	12X20X2	1,5	■ CS490M15AAA	31,00
Revers.profiled knife	12X20X2	2	■ CS490M20AAA	31,00
Revers.profiled knife	12X20X2	3	■ CS490M30AAA	31,00
Spec. profile			■ CS490M99	On request
Clamping wedge screw	M4X6X7		■ WV008	3,00
"T" Torx key	T15		● ACHTC15AAAAA	11,80

NOTE

■ Utensili non a magazzino, quantità minima d'ordine: **2 pezzi**.
Tools not ready in stock minimum order quantity: **2 pieces**.

Il prezzo include coltelli e 1 chiave di regolazione.
The price included knives and 1 screwdriver.

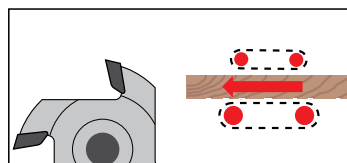
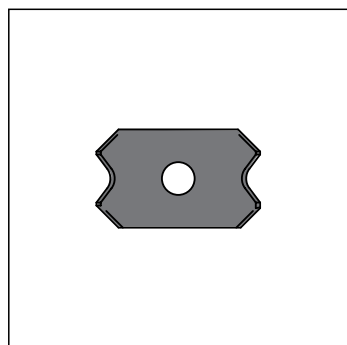
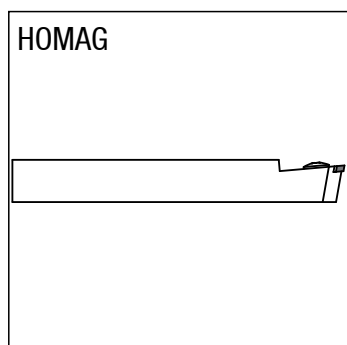

TAGLIO / SEZIONATURA
SAWING

DIAMANTE
DIAMOND

FRESATURA
CUTTING

PANTOGRAFATURA
ROUTING

FORATURA
BORING

MANDRINI / ATTACCHI
CHUCKS & CLAMPING SYSTEM

RICAMBI E LAVORAZIONI SUPP.
SPARE PARTS & ADD. WORKING

Raschiatori portacoltello
raggiato per bordatrici

Radienziehklängen

Porte outils
d'affleurance

Фрезы
мультирадиусные
для кромочных

T492

HW Scraper holders with edge and radius profile

TAGLIO / SEZIONATURA
SAWING

DIAMANTE
DIAMOND

FRESATURA
CUTTING

PANTOGRAFATURA
ROUTING

FORATURA
BORING

MANDRINI / ATTACCHI
CHUCKS & CLAMPING SYSTEM

RICAMBI E LAVORAZIONI SUPP.
SPARE PARTS & ADD. WORKING

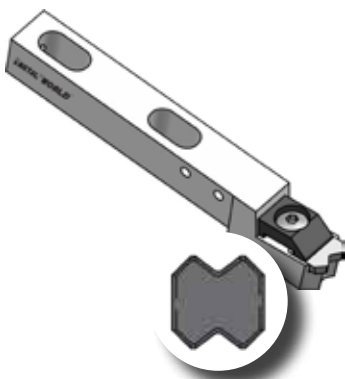
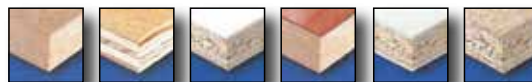

Costruiti con corpo in acciaio bonificato • Coltelli in HW a fissaggio meccanico • Da montare su macchine bordatrici • Adatti per rifinire il profilo raggiato ABS.

Body in hardened and tempered steel • HW turnover knives • To mount on edge banding machines • Suitable for finishing ABS edges with radius profile

TO MOUNT ON **scm** EDGE BANDING MACHINES

Dimensions	F	Z	Code	€
112X16,5X18,5	16,5X14X5	1	■ T492M1121618	187,00

Spec.

T492M99

● = Ready in stock ■ = Delivery time 20 working days △ = On request

SPARE PARTS

Type	Dimensions	Code	€
Revers. profiled knife	12,7X12,7X3,20	■ CS492M10AAA	35,00
Revers. profiled knife	12,7X12,7X3,20	■ CS492M15AAA	35,00
Revers. profiled knife	12,7X12,7X3,20	■ CS492M20AAA	35,00
Revers. profiled knife	12,7X12,7X3,20	■ CS492M30AAA	35,00
Spec. profile		● CS492M99	On request
Clamping wedge		■ ETASS492	32,40
Screw	M5X8	● WV049	3,00
"T" allen key	Esag. 4	● ACHETO4AAAAA	8,20

NOTE

■ Utensili non a magazzino, quantità minima d'ordine: **2 pezzi**.
Tools not ready in stock minimum order quantity: **2 pieces**.

Il prezzo include coltelli e 1 chiave di regolazione.
The price included knives and 1 screwdriver.



T494

HW Multiradius scraper holders

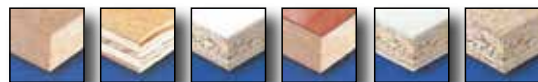

Costruiti con corpo in acciaio bonificato • Coltelli in HW a fissaggio meccanico • Profilo multiraggio R.1-R.1,5-R.2 • Da montare su macchine bordatrici • Adatti per rifinire il profilo raggiato ABS

Body in hardened and tempered steel • HW turnover knives • To mount on edge banding machines • Multiradius profile R.1 - R.1,5 - R.2 • Suitable for finishing ABS edges with radius profile

TO MOUNT ON **scm** EDGE BANDING MACHINES

Dimensions	F	Z	Code	€
113X40	20X14	1	■ T494M11330AA	261,00

Spec. T494M99

● = Ready in stock ■ = Delivery time 20 working days △ = On request

SPARE PARTS

Type	Dimensions	Code	€
Profiled knife	34X12,7X3	■ WCS494MAAAAA	65,00
Clamping wedge		■ ETASS494	54,00
Screw	M5X8	● WV050	3,00
"T" allen key	Esag. 4	● ACHET04AAAAA	8,20

NOTE

■ Utensili non a magazzino, quantità minima d'ordine: **2 pezzi**.
Tools not ready in stock minimum order quantity: **2 pieces**.

Il prezzo include coltelli e 1 chiave di regolazione.
The price included knives and 1 screwdriver.

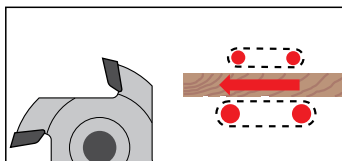
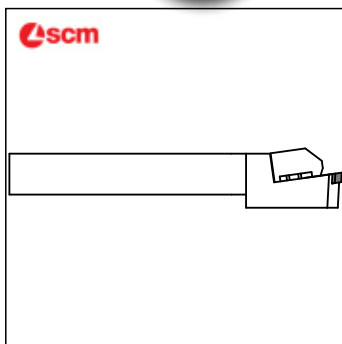

TAGLIO / SEZIONATURA
SAWING

DIAMANTE
DIAMOND

FRESATURA
CUTTING

PANTOGRAFATURA
ROUTING

FORATURA
BORING

MANDRINI / ATTACCHI
CHUCKS & CLAMPING SYSTEM

RICAMBI E LAVORAZIONI SUPP.
SPARE PARTS & ADD. WORKING

